

Robert Bosch Power Tools GmbH
70538 Stuttgart
GERMANY

www.bosch-pt.com

1 609 92A 1TX (2013.11) PS / 42 ASIA



1 609 92A 1TX

GBH Professional

8-45 D | 8-45 DV



- en** Original instructions
- cn** 正本使用说明书
- tw** 原始使用說明書
- ko** 사용 설명서 원본
- th** หนังสือคู่มือการใช้งานฉบับต้นแบบ
- id** Petunjuk-Petunjuk untuk Penggunaan Orisinal
- vi** Bản gốc hướng dẫn sử dụng



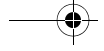

English	Page	3
中文	页	8
中文	頁	12
한국어	페이지	16
ภาษาไทย	หน้า	21
Bahasa Indonesia	Halaman	26
Tiếng Việt	Trang	31

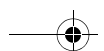
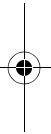

English

General Power Tool Safety Warnings

⚠ WARNING Read all safety warnings and all instructions. Failure to follow the warnings and instructions may result in electric shock, fire and/or serious injury.

Save all warnings and instructions for future reference.

The term "power tool" in the warnings refers to your mains-operated (corded) power tool or battery-operated (cordless) power tool.

Work area safety

- ▶ **Keep work area clean and well lit.** Cluttered or dark areas invite accidents.
- ▶ **Do not operate power tools in explosive atmospheres, such as in the presence of flammable liquids, gases or dust.** Power tools create sparks which may ignite the dust or fumes.
- ▶ **Keep children and bystanders away while operating a power tool.** Distractions can cause you to lose control.

Electrical safety

- ▶ **Power tool plugs must match the outlet. Never modify the plug in any way. Do not use any adapter plugs with earthed (grounded) power tools.** Unmodified plugs and matching outlets will reduce risk of electric shock.
- ▶ **Avoid body contact with earthed or grounded surfaces, such as pipes, radiators, ranges and refrigerators.** There is an increased risk of electric shock if your body is earthed or grounded.
- ▶ **Do not expose power tools to rain or wet conditions.** Water entering a power tool will increase the risk of electric shock.
- ▶ **Do not abuse the cord. Never use the cord for carrying, pulling or unplugging the power tool. Keep cord away from heat, oil, sharp edges and moving parts.** Damaged or entangled cords increase the risk of electric shock.
- ▶ **When operating a power tool outdoors, use an extension cord suitable for outdoor use.** Use of a cord suitable for outdoor use reduces the risk of electric shock.
- ▶ **If operating a power tool in a damp location is unavoidable, use a residual current device (RCD) protected supply.** Use of an RCD reduces the risk of electric shock.

Personal safety

- ▶ **Stay alert, watch what you are doing and use common sense when operating a power tool. Do not use a power tool while you are tired or under the influence of drugs, alcohol or medication.** A moment of inattention while operating power tools may result in serious personal injury.
- ▶ **Use personal protective equipment. Always wear eye protection.** Protective equipment such as dust mask, non-skid safety shoes, hard hat, or hearing protection used for appropriate conditions will reduce personal injuries.

- ▶ **Prevent unintentional starting. Ensure the switch is in the off-position before connecting to power source and/or battery pack, picking up or carrying the tool.** Carrying power tools with your finger on the switch or energising power tools that have the switch on invites accidents.
- ▶ **Remove any adjusting key or wrench before turning the power tool on.** A wrench or a key left attached to a rotating part of the power tool may result in personal injury.
- ▶ **Do not overreach. Keep proper footing and balance at all times.** This enables better control of the power tool in unexpected situations.
- ▶ **Dress properly. Do not wear loose clothing or jewelry. Keep your hair, clothing and gloves away from moving parts.** Loose clothes, jewellery or long hair can be caught in moving parts.
- ▶ **If devices are provided for the connection of dust extraction and collection facilities, ensure these are connected and properly used.** Use of dust collection can reduce dust-related hazards.

Power tool use and care

- ▶ **Do not force the power tool. Use the correct power tool for your application.** The correct power tool will do the job better and safer at the rate for which it was designed.
- ▶ **Do not use the power tool if the switch does not turn it on and off.** Any power tool that cannot be controlled with the switch is dangerous and must be repaired.
- ▶ **Disconnect the plug from the power source and/or the battery pack from the power tool before making any adjustments, changing accessories, or storing power tools.** Such preventive safety measures reduce the risk of starting the power tool accidentally.
- ▶ **Store idle power tools out of the reach of children and do not allow persons unfamiliar with the power tool or these instructions to operate the power tool.** Power tools are dangerous in the hands of untrained users.
- ▶ **Maintain power tools. Check for misalignment or binding of moving parts, breakage of parts and any other condition that may affect the power tool's operation. If damaged, have the power tool repaired before use.** Many accidents are caused by poorly maintained power tools.
- ▶ **Keep cutting tools sharp and clean.** Properly maintained cutting tools with sharp cutting edges are less likely to bind and are easier to control.
- ▶ **Use the power tool, accessories and tool bits etc. in accordance with these instructions, taking into account the working conditions and the work to be performed.** Use of the power tool for operations different from those intended could result in a hazardous situation.

Service

- ▶ **Have your power tool serviced by a qualified repair person using only identical replacement parts.** This will ensure that the safety of the power tool is maintained.

4 | English

Hammer Safety Warnings

- ▶ **Wear ear protectors.** Exposure to noise can cause hearing loss.
- ▶ **Use auxiliary handle(s), if supplied with the tool.** Loss of control can cause personal injury.
- ▶ **Hold power tool by insulated gripping surfaces, when performing an operation where the cutting accessory may contact hidden wiring or its own cord.** Cutting accessory contacting a "live" wire may make exposed metal parts of the power tool "live" and could give the operator an electric shock.

Products sold in GB only: Your product is fitted with a BS 1363/A approved electric plug with internal fuse (ASTA approved to BS 1362).

If the plug is not suitable for your socket outlets, it should be cut off and an appropriate plug fitted in its place by an authorised customer service agent. The replacement plug should have the same fuse rating as the original plug.

The severed plug must be disposed of to avoid a possible shock hazard and should never be inserted into a mains socket elsewhere.

Products sold in AUS and NZ only: Use a residual current device (RCD) with a rated residual current of 30 mA or less.

Additional Safety and Working Instructions

- ▶ **Observe the mains voltage! The voltage of the power source must correspond with the data on the type plate of the machine.**
- ▶ **Use appropriate detectors to determine if utility lines are hidden in the work area or call the local utility company for assistance.** Contact with electric lines can lead to fire and electric shock. Damaging a gas line can lead to explosion. Penetrating a water line causes property damage.
- ▶ **Firmly tighten the auxiliary handle, hold the machine firmly with both hands while working and keep proper footing and balance at all times.** The machine is securely guided with both hands.
- ▶ **Select the correct operating mode and the suitable application tool for the material to be worked.**
- ▶ **Insert the SDS-max application tool:** Check the latching by pulling the tool.
- ▶ **Replace a damaged dust protection cap immediately.** The dust protection cap largely prevents the penetration of drilling dust into the tool holder during operation. When inserting the tool, pay attention that the dust protection cap is not damaged.
- ▶ **Dusts from materials such as lead-containing coatings, some wood types, minerals and metal can be harmful to one's health and cause allergic reactions, lead to respiratory infections and/or cancer.** Materials containing asbestos may only be worked by specialists.
 - As far as possible, use a dust extraction system suitable for the material.

- Provide for good ventilation of the working place.
- It is recommended to wear a P2 filter-class respirator.

Observe the relevant regulations in your country for the materials to be worked.

- ▶ **If the application tool should become blocked, switch the machine off. Loosen the application tool.**
- ▶ **Before switching on the power tool, make sure that the application tool moves freely.** When switching on with a blocked drilling tool, high torque reaction can occur.
- ▶ To save energy, only switch the power tool on when using it.
- ▶ **Always wait until the machine has come to a complete stop before placing it down.** The tool insert can jam and lead to loss of control over the power tool.
- ▶ **Restarting Protection**
In chiselling mode, the restarting protection prevents uncontrolled starting of the machine after a power failure.
 - To **restart the operation**, switch the On/Off switch to the Off position and start the machine again.





▶ Vibration Damper (GBH 8-45 DV)

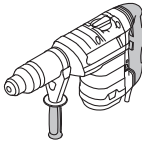
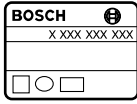

The integrated vibration damper reduces occurring vibrations.

Symbols

The following symbols are important for reading and understanding the operating instructions. Please take note of the symbols and their meaning. The correct interpretation of the symbols will help you to use the machine in a better and safer manner.

Symbol	Meaning
	GBH 8-45 D/ GBH 8-45 DV: Rotary Hammer Grey-marked area: Handle (insulated gripping surface)
	Article number
	Read all safety warnings and all instructions
	Before any work on the machine itself, pull the mains plug from the socket outlet
	Wear protective gloves

Symbol	Meaning
	Always wear ear protection
	Wear safety glasses/goggles
	Movement direction
	Reaction direction
	Next step of action
	Prohibited action
	Hammer Drilling
	Chiselling
	Vario-Lock
	Switching On
	Switching Off
	On/Off switch lock-on
	Releasing the On/Off switch
	Low speed/impact rate
	High speed/impact rate
	Tool holder
	Apply a light coat of grease to the shank end of the application tool
	Service Indicator
P_1	Rated power input
E	Impact energy per stroke according to EPTA-Procedure 05/2009
n_0	No-load speed

Symbol	Meaning
	Restarting Protection
\varnothing	Drilling diameter, max.
	Concrete
	Brickwork
	Twist drill bit
	Break-through drill bit
	Core bit
	Weight according to EPTA-Procedure 01:2014
	Protection class
L_{WA}	Sound power level
L_{pA}	Sound pressure level
a_h	Vibration total value
K	Uncertainty

Delivery Scope

Rotary hammer, auxiliary handle.
Application tools and other accessories shown or described are not part of the standard delivery scope.

A complete overview of accessories can be found in our accessories program.

Intended Use

The machine is intended for hammer drilling in concrete, brick and stone as well as for chiselling.

Technical Data

The technical data of the machine are listed in the table on page 37.

The values given are valid for a nominal voltage [U] of 230 V. For different voltages and models for specific countries, these values can vary.

6 | English

Mounting and Operation

The following table indicates the action objectives for mounting and operation of the power tool. The instructions for each action objective are shown aside. Depending on the type of application, various instruction combinations are required. Observe the safety instructions.

Action	Figure	Please observe	Page
Insert the SDS-max application tool			38
Removing the SDS-max application tool			38
Selecting the Operating Mode			39
Changing the chisel position (Vario-Lock)			39
Changing the position of the auxiliary handle			39
Switching On/Off in Drilling Mode			40
Switching On/Off in Chiselling Mode			40
Adjusting the Speed			40
Observing the service indicator			41

Maintenance and Cleaning

► For safe and proper working, always keep the machine and ventilation slots clean.

If the replacement of the supply cord is necessary, this has to be done by Bosch or an authorized Bosch service agent in order to avoid a safety hazard.

Service Indicator

(see Fig. 9, page 41)

When the carbon brushes are worn out, the machine switches itself off. This is indicated approx. 8 hours beforehand by the lighting or blinking of the service indicator. The machine must then be sent to an after-sales service agent. Addresses are listed in the Section "After-sales Service and Application Service".

Service indicator flashes in regular intervals, the machine is defective. In this case, do not continue to use the machine and send it immediately to an after-sales service agent.

After-sales Service and Application Service

In all correspondence and spare parts order, please always include the 10-digit article number given on the type plate of the machine.

Our after-sales service responds to your questions concerning maintenance and repair of your product as well as spare parts. Exploded views and information on spare parts can also be found under:

www.bosch-pt.com

Bosch's application service team will gladly answer questions concerning our products and their accessories.

People's Republic of China

China Mainland

Bosch Power Tools (China) Co., Ltd.
567, Bin Kang Road
Bin Jiang District 310052
Hangzhou, P. R. China
Service Hotline: 4008268484
Fax: (0571) 87774502
E-Mail: contact.ptcn@cn.bosch.com
www.bosch-pt.com.cn

HK and Macau Special Administrative Regions

Robert Bosch Hong Kong Co. Ltd.
21st Floor, 625 King's Road
North Point, Hong Kong
Customer Service Hotline: +852 2101 0235
Fax: +852 2590 9762
E-Mail: info@hk.bosch.com
www.bosch-pt.com.hk

Indonesia

PT. Multi Mayaka
Kawasan Industri Pulogadung
Jalan Rawa Gelam III No. 2
Jakarta 13930
Indonesia
Tel.: (021) 46832522
Fax: (021) 46828645/6823
E-Mail: sales@multimayaka.co.id
www.bosch-pt.co.id

Philippines

Robert Bosch, Inc.
28th Floor Fort Legend Towers,
3rd Avenue corner 31st Street,
Fort Bonifacio Global City,
1634 Taguig City, Philippines
Tel.: (02) 8703871
Fax: (02) 8703870
matheus.contiero@ph.bosch.com
www.bosch-pt.com.ph

Bosch Service Center:
9725-27 Kamagong Street
San Antonio Village
Makati City, Philippines
Tel.: (02) 8999091
Fax: (02) 8976432
rosalie.dagdagan@ph.bosch.com

Malaysia

Robert Bosch (S.E.A.) Sdn. Bhd.
No. 8A, Jalan 13/6
G.P.O. Box 10818
46200 Petaling Jaya
Selangor, Malaysia
Tel.: (03) 79663194
Fax: (03) 79583838
cheehoe.on@my.bosch.com
Toll-Free: 1800 880188
www.bosch-pt.com.my

Thailand

Robert Bosch Ltd.
Liberty Square Building
No. 287, 11 Floor
Silom Road, Bangrak
Bangkok 10500
Tel.: 02 6393111, 02 6393118
Fax: 02 2384783
Robert Bosch Ltd., P. O. Box 2054
Bangkok 10501, Thailand
www.bosch.co.th

8 | 中文

Bosch Service – Training Centre
La Salle Tower Ground Floor Unit No.2
10/11 La Salle Moo 16
Srinakharin Road
Bangkaew, Bang Plee
Samutprakarn 10540
Thailand
Tel.: 02 7587555
Fax: 02 7587525

Singapore

Robert Bosch (SEA) Pte. Ltd.
11 Bishan Street 21
Singapore 573943
Tel.: 6571 2772
Fax: 6350 5315
leongheng.leow@sg.bosch.com
Toll-Free: 1800 3338333
www.bosch-pt.com.sg

Vietnam

Robert Bosch Vietnam Co. Ltd
10/F, 194 Golden Building
473 Dien Bien Phu Street
Ward 25, Binh Thanh District
84 Ho Chi Minh City
Vietnam
Tel.: (08) 6258 3690 ext. 413
Fax: (08) 6258 3692
hie.u.lagia@vn.bosch.com
www.bosch-pt.com

Australia, New Zealand and Pacific Islands

Robert Bosch Australia Pty. Ltd.
Power Tools
Locked Bag 66
Clayton South VIC 3169
Customer Contact Center
Inside Australia:
Phone: (01300) 307044
Fax: (01300) 307045
Inside New Zealand:
Phone: (0800) 543353
Fax: (0800) 428570
Outside AU and NZ:
Phone: +61 3 95415555
www.bosch.com.au

Disposal

The machine, accessories and packaging should be sorted for environmental-friendly recycling.

Do not dispose of power tools into household waste!

Subject to change without notice.

中文**电动工具通用安全警告**

警告！ 阅读所有警告和所有说明！不遵照以下警告和说明会导致电击、着火和/或严重伤害。

保存所有警告和说明书以备查阅。

在所有下列的警告中术语“电动工具”指市电驱动（有线）电动工具或电池驱动（无线）电动工具。

工作场地的安全

- ▶ **保持工作场地清洁和明亮。** 混乱和黑暗的场地会引发事故。
- ▶ **不要在易爆环境，如有易燃液体、气体或粉尘的环境下操作电动工具。** 电动工具产生的火花会点燃粉尘或气体。
- ▶ **让儿童和旁观者离开后操作电动工具。** 注意力不集中会使操作者失去对工具的控制。

电气安全

- ▶ **电动工具插头必须与插座相配。绝不能以任何方式改装插头。** 需接地的电动工具不能使用任何转换插头。未经改装的插头和相配的插座将减少电击危险。
- ▶ **避免人体接触接地表面，如管道、散热片和冰箱。** 如果你身体接地会增加电击危险。
- ▶ **不得将电动工具暴露在雨或潮湿环境中。** 水进入电动工具将增加电击危险。
- ▶ **不得滥用电线。绝不能用电线搬运、拉动电动工具或拔出其插头。** 使电线远离热源、油、锐边或运动部件。受损或缠绕的软线会增加电击危险。
- ▶ **当在户外使用电动工具时，使用适合户外使用的外接软线。** 适合户外使用的软线将减少电击危险。
- ▶ **如果在潮湿环境下操作电动工具是不可避免的，应使用剩余电流动作保护器（RCD）。使用 RCD 可减小电击危险。**

人身安全

- ▶ **保持警觉，当操作电动工具时关注所从事的操作并保持清醒。** 当你感到疲倦，或在有药物、酒精或治疗反应时，不要操作电动工具。在操作电动工具时瞬间的疏忽会导致严重人身伤害。
- ▶ **使用个人防护装置。始终佩戴护目镜。** 安全装置，诸如适当条件下使用防尘面具、防滑安全鞋、安全帽、听力防护等装置能减少人身伤害。
- ▶ **防止意外起动。确保开关在连接电源和/或电池盒、拿起或搬运工具时处于关断位置。** 手指放在已接通电源的开关上或开关处于接通时插入插头可能会导致危险。

- ▶ 在电动工具接通之前，拿掉所有调节钥匙或扳手。遗留在电动工具旋转零件上的扳手或钥匙会导致人身伤害。
- ▶ 手不要伸展得太长。时刻注意立足点和身体平衡。这样在意外情况下能很好地控制电动工具。
- ▶ 着装适当。不要穿宽松衣服或佩戴饰品。让衣服、手套和头发远离运动部件。宽松衣服、佩饰或长发可能会卷入运动部件中。
- ▶ 如果提供了与排屑、集尘设备连接用的装置，要确保他们连接完好且使用得当。使用这些装置可减少尘屑引起的危险。

电动工具使用和注意事项

- ▶ 不要滥用电动工具，根据用途使用适当的电动工具。选用适当设计的电动工具会使你工作更有效、更安全。
- ▶ 如果开关不能接通或断开工具电源，则不能使用该电动工具。不能用开关来控制的电动工具是危险的且必须进行修理。
- ▶ 在进行任何调节、更换附件或贮存电动工具之前，必须从电源上拔掉插头和 / 或使电池盒与工具脱开。这种防护性措施将减少工具意外起动的危险。
- ▶ 将闲置不用的电动工具贮存在儿童所及范围之外，并且不要让不熟悉电动工具或对这些说明不了解的人操作电动工具。电动工具在未经培训的用户手中是危险的。
- ▶ 保养电动工具。检查运动部件是否调整到位或卡住，检查零件破损情况和影响电动工具运行的其他状况。如有损坏，电动工具应在使用前修理好。许多事故由维护不良的电动工具引发。
- ▶ 保持切削刀具锋利和清洁。保养良好的有锋利切削刃的刀具不易卡住而且容易控制。
- ▶ 按照使用说明书，考虑作业条件和进行的作业来使用电动工具、附件和工具的刀头等。将电动工具用于那些与其用途不符的操作可能会导致危险。

维修

- ▶ 将你的电动工具送交专业维修人员，使用同样的备件进行修理。这样将确保所维修的电动工具的安全性。

锤类工具的安全警告

- ▶ 戴好耳罩。暴露在噪声中会引起听力损伤。
- ▶ 使用随工具提供的辅助手柄。操作失手会引起人身伤害。
- ▶ 在切削附件可能触及暗线或其自身软线之处进行操作时，要通过绝缘握持面来握持工具。切削附件碰到带电导线会使工具外露的金属零件带电从而使操作者受到电击。

进一步的安全规章和工作指示

- ▶ 注意电源的电压！电源的电压必须和电动工具铭牌上标示的电压一致。
- ▶ 使用合适的侦测器，以便找出隐藏着的电源线的位位置。或者向当地的供电单位索取相关资料。钻穿电线会造成火灾并遭受电击。损坏瓦斯管会引起爆炸。如果水管被刺穿了会导致财物损失。
- ▶ 拧紧辅助手柄。工作时要使用双手握紧电动工具并且要确保立足稳固 使用双手才能够稳定地操作电动工具。
- ▶ 根据待加工的物料选择正确的操作功能以及合适的工具。
- ▶ 安装 SDS-max- 工具：抽拉工具以确定它是否正确锁紧了。
- ▶ 必须马上更换损坏的防尘盖。防尘盖可以防止工作时的钻孔废尘侵入夹头中。安装 工具时要小心，勿损坏防尘盖。
- ▶ 含铅的颜料以及某些木材、矿物和金属的加工废尘有害健康、可能造成过敏、让操作者感染 呼吸道疾病和 / 或罹患癌症。只有经过专业培训的人员才能够加工含石棉的物料。
 - 尽可能使用适合物料的吸尘装置。
 - 工作场所要保持空气流通。
 - 最好佩戴 P2 滤网等级的口罩。
 请留心并遵守贵国和加工物料有关的法规。
- ▶ 如果安装在机器上的工具被夹住了，要关闭电动工具。拧紧安装在机器上的工具。
- ▶ 开动电动工具之前，先检查安装在机器上的工具是否能够自由旋转。开动机器时如果安装在机器上的工具被卡住了，会产生高的反作用扭力。
- ▶ 为了节约能源，只在当您使用机器时，才开动电动工具。
- ▶ 等待电动工具完全静止后才能够放下机器。机器上的工具可能在工作中被夹住，而令您无法控制电动工具。

防止再起动装置

防止再起动装置能够防止电动工具在进行凿击时，因为电源中断尔后突然失控地再起动。

- 再度开动，先关闭起停开关，然后再重新开动机

减震装置 (GBH 8-45 DV)









内建的减震系统，能够减轻工作时产生的震动。

代表符号

以下的符号可以帮助您正确地使用本机器。请仔细阅读各符号及它们的代表意思。正确了解各符号所代表的意义，可以帮助您更有把握更安全地操作本机器。

10 | 中文

符号	含义
	GBH 8-45 D/ GBH 8-45 DV: 锤钻 打上灰色记号的部位: 手柄 (绝缘的握持位置)
	物品代码
	阅读所有的安全规章和说明
	在电动工具上进行任何修护工作之前必须从电源插座上拔出插头
	佩戴防护手套
	请佩戴耳罩
	请佩戴护目镜
	移动方向
	反应方向
	下一个处理步骤
	禁止的行为
	锤钻
	凿击
	Vario-Lock
	开动
	关闭
	锁定起停开关
	解除起停开关的锁定

符号	含义
	小转速 / 冲击次数
	大转速 / 冲击次数
	工具夹头
	在工具插柄的末端涂抹少许油脂
	维修指示灯
P_1	额定输入功率
E	单一冲击强度符合 EPTA-Procedure 05/2009 的规定
n_0	无负载转速
	防止再起装置
\emptyset	最大钻孔直径
	混凝土
	泥墙
	螺旋钻头
	冲破钻头
	空心钻头
	重量符合 EPTA-Procedure 01:2014
	绝缘等级
L_{WA}	声功率水平
L_{pA}	声压水平
a_h	振动总值
K	不确定系数

供货范围

锤钻, 辅助手柄。
安装在机器上的工具以及图表或说明上提到的附件, 并不包含在基本供货范围中。
在本公司的附件清单中标列了完整的附件。

按照规定使用机器

本机器适合在混凝土，砖块和石材上进行锤钻作业。另外也可以使用本机器进行凿击。

技术数据

本产品的技术数据列在本使用说明书 37 页的表格中。本说明书提供的参数是以 230 V 为依据，于低电压地区，此数据有可能不同。

安装和操作

以下表格显示了在安装和使用电动工具时的执行目的。表格中的图形显示了与执行目的相关的提示。因为用途不同所以会有不同的提示组合。请留心安全规章。

执行目的	图片	请注意	页数
安装 SDS-max- 工具			38
拆除 SDS-max- 工具			38
选择操作功能			39
改变凿头的位置 (Vario-Lock)			39
转动辅助手柄			39
进行钻孔作业时的开机 / 关机方式			40
进行凿击作业时的开机 / 关机方式			40
调整转速			40
留心维修指示灯			41

12 | 中文

维修和清洁

- ▶ **电动工具和通风间隙都必须保持清洁，这样才能够提高工作品质 and 安全性。**

如果必须更换连接线，务必把这项工作交给博世或者经授权的博世电动工具顾客服务处执行，以避免危害机器的安全性能。

维修指示灯

(参考插图 9, 页数 41)

如果碳刷耗尽了，电动工具会自动关闭。在碳刷即将用尽前 8 个小时，维修指示灯 会亮起或闪烁。此时必须把电动工具交给博世顾客服务处维修。顾客服务处的地址请参阅 "顾客服务处和顾客咨询中心"。

如果维修指示灯有规律地闪烁，代表电动工具已经故障了。如果发生上述 情况则不可以继续使用电动工具，必须马上将它交给顾客服务处修理。

顾客服务处和顾客咨询中心

询问和订购备件时，务必提供机器铭牌上标示的 10 位数字物品代码。

本公司顾客服务处负责回答有关本公司产品的修理，维护和备件的问题。以下的网页中有爆炸图和备件的资料：
www.bosch-pt.com

博世顾客咨询团队非常乐意为您解答有关本公司产品及附件的问题。

有关保证，维修或更换零件事宜，请向合格的经销商查询。

中国大陆

博世电动工具（中国）有限公司
中国 浙江省 杭州市
滨江区滨康路 567 号
邮政编码：310052
免费服务热线：4008268484
传真：(0571) 87774502
电邮：contact.ptcn@cn.bosch.com
www.bosch-pt.com.cn

罗伯特·博世有限公司
香港北角英皇道 625 号 21 楼
客户服务热线：+852 2101 0235
传真：+852 2590 9762
电邮：info@hk.bosch.com
网站：www.bosch-pt.com.hk

制造商地址：

Robert Bosch Power Tools GmbH
罗伯特·博世电动工具有限公司
70538 Stuttgart / GERMANY
70538 斯图加特 / 德国

处理废弃物

必须以符合环保的方式，回收再利用损坏的机器、附件和废弃的包装材料。

不可以把电动工具丢入家庭垃圾中！

保留修改权。

中文

電動工具通用安全警告

警告 閱讀所有警告和所有說明。不遵照以下警告和說明會導致電擊、著火和/或嚴重傷害。

保存所有警告和說明書以備查閱。

在所有下列的警告中術語 "電動工具" 指市電驅動 (有線) 電動工具或電池驅動 (無線) 電動工具。

工作場地的安全

- ▶ **保持工作場地清潔和明亮。** 混亂和黑暗的場地會引發事故。
- ▶ **不要在易爆環境，如有易燃液體、氣體或粉塵的環境下操作電動工具。** 電動工具產生的火花會點燃粉塵或氣體。
- ▶ **讓兒童和旁觀者離開後操作電動工具。** 注意力不集中會使你失去對工具的控制。

電氣安全

- ▶ **電動工具插頭必須與插座相配。絕不能以任何方式改裝插頭。** 需接地的電動工具不能使用任何轉換插頭。未經改裝的插頭和相配的插座將減少電擊危險。
- ▶ **避免人體接觸接地表面，如管道、散熱片和冰箱。** 如果你身體接地會增加電擊危險。
- ▶ **不得將電動工具暴露在雨中或潮濕環境中。** 水進入電動工具將增加電擊危險。
- ▶ **不得濫用電線。絕不能用電線搬運、拉動電動工具或拔出其插頭。使電線遠離熱源、油、銳邊或運動部件。** 受損或纏繞的軟線會增加電擊危險。
- ▶ **當在戶外使用電動工具時，使用適合戶外使用的外接軟線。** 適合戶外使用的軟線，將減少電擊危險。
- ▶ **如果在潮濕環境下操作電動工具是不可避免的，應使用剩餘電流動作保護器 (RCD)。** 使用 RCD 可減小電擊危險。

人身安全

- ▶ **保持警覺，當操作電動工具時關注所從事的操作並保持清醒。當你感到疲倦，或在有藥物、酒精或治療反應時，不要操作電動工具。** 在操作電動工具時瞬間的疏忽會導致嚴重人身傷害。

- ▶ **使用個人防護裝置。始終佩戴護目鏡。** 安全裝置，諸如適當條件下使用防塵面具、防滑安全鞋、安全帽、聽力防護等裝置能減少人身傷害。
- ▶ **防止意外起動。確保開關在連接電源和 / 或電池盒、拿起或搬運工具時處於關斷位置。** 手指放在已接通電源的開關上或開關處於接通時插入插頭可能會導致危險。
- ▶ **在電動工具接通之前，拿掉所有調節鑰匙或扳手。** 遺留在電動工具旋轉零件上的扳手或鑰匙會導致人身傷害。
- ▶ **手不要伸展得太長。時刻注意立足點和身體平衡。** 這樣在意外情況下能很好地控制電動工具。
- ▶ **著裝適當。不要穿寬鬆衣服或佩戴飾品。讓你的衣服、手套和頭髮遠離運動部件。** 寬鬆衣服、佩飾或長髮可能會捲入運動部件中。
- ▶ **如果提供了與排屑、集塵設備連接用的裝置，要確保他們連接完好且使用得當。** 使用這些裝置可減少塵屑引起的危險。

電動工具使用和注意事項

- ▶ **不要濫用電動工具，根據用途使用適當的電動工具。** 選用適當設計的電動工具會使你工作更有效、更安全。
- ▶ **如果開關不能接通或關斷工具電源，則不能使用該電動工具。** 不能用開關來控制的電動工具是危險的且必須進行修理。
- ▶ **在進行任何調節、更換附件或貯存電動工具之前，必須從電源上拔掉插頭和 / 或使電池盒與工具脫開。** 這種防護性措施將減少工具意外起動的危險。
- ▶ **將閒置不用的電動工具貯存在兒童所及範圍之外，並且不要讓不熟悉電動工具或對這些說明不瞭解的人操作電動工具。** 電動工具在未經培訓的用戶手中是危險的。
- ▶ **保養電動工具。檢查運動部件是否調整到位或卡住，檢查零件破損情況和影響電動工具運行的其他狀況。如有損壞，電動工具應在使用前修理好。** 許多事故由維護不良的電動工具引發。
- ▶ **保持切削刀具鋒利和清潔。** 保養良好的有鋒利切削刃的刀具不易卡住而且容易控制。
- ▶ **按照使用說明書，考慮作業條件和進行的作業來使用電動工具、附件和工具的刀頭等。** 將電動工具用於那些與其用途不符的操作可能會導致危險。

檢修

- ▶ **將你的電動工具送交專業維修人員，必須使用同樣的備件進行更換。** 這樣將確保所維修的電動工具的安全性。

針對電鎚的安全規章

- ▶ **佩戴耳罩。** 工作噪音會損壞聽力。

- ▶ **如果電動工具提供了輔助手柄便要使用它。** 操作時失控可能導致傷害。
- ▶ **如果安裝在此裝置上的切割配件可能會在作業期間割到暗藏的電線或自身的電源線，請務必從裝置握把上的絕緣處來握住該裝置。** 切割配件萬一接觸到帶電導線，可能會連帶使裝置上的金屬部件帶電，進而導致操作者觸電。

進一步的安全規章和工作指示

- ▶ **注意電源的電壓！** 電源的電壓必須和電動工具銘牌上標示的電壓一致。
- ▶ **使用合適的偵測器，以便找出隱藏著的電源線的位置。或者向當地的供電單位索取相關資料。** 鑽穿電線會造成火災並遭受電擊。損壞瓦斯管會引起爆炸。如果水管被刺穿了會導致財物損失。
- ▶ **擰緊輔助手柄。工作時要使用雙手擰緊電動工具並且要確保立足穩固。** 使用雙手才能夠穩定地操作電動工具。
- ▶ **根據待加工的物料選擇正確的操作功能以及合適的工具。**
- ▶ **安裝 SDS-max- 工具：** 抽拉工具以確定它是否正確鎖緊了。
- ▶ **必須馬上更換損壞的防塵蓋。** 防塵蓋可以防止工作時的鑽孔廢塵侵入夾頭中。安裝工具時要小心，勿損壞防塵蓋。
- ▶ **含鉛的顏料以及某些木材、礦物和金屬的加工廢塵有害健康、可能造成過敏、讓操作者感染呼吸道疾病和 / 或癌症。** 只有經過專業訓練的人員才能夠加工含石棉的物料。
 - 盡可能使用適合物料的吸塵裝置。
 - 工作場所要保持空氣流通。
 - 最好佩戴 P2 濾網等級的口罩。

請留心並遵守貴國和加工物料有關的法規。

- ▶ **如果安裝在機器上的工具被夾住了，要關閉電動工具。擰松安裝在機器上的工具。**
- ▶ **開動電動工具之前，先檢查安裝在機器上的工具是否能夠自由旋轉。** 開動機器時如果安裝在機器上的工具被卡住了，會產生高的反作用扭力。
- ▶ **為了節約能源，只在當您要使用機器時，才開動電動工具。**
- ▶ **等待電動工具完全靜止後才能夠放下機器。** 機器上的工具可能在工作中被夾住，而令您無法控制電動工具。
- ▶ **防止再起動裝置**
 - 防止再起動裝置能夠防止電動工具在進行擊擊時，因為電源中斷爾後突然失控地再起動。
 - **再度開動，** 先關閉起停開關，然後再重新開動機器。

14 | 中文

► 減震裝置 (GBH 8-45 DV)



內建的減震系統，能夠減輕工作時產生的震動。

代表符號

以下的符號可以幫助您正確地使用本機器。請詳細閱讀各符號及它們的代表意思。正確了解各符號所代表的意義，可以幫助您更有把握更安全地操作本機器。

符號	含義
	GBH 8-45 D/ GBH 8-45 DV: 鏈鑽 打上灰色記號的部位：手柄（絕緣的握持位置）
	物品代碼
	閱讀所有的安全規章和說明
	在電動工具上進行任何修護工作之前必須從電源插座上拔出插頭
	佩戴防護手套
	請佩戴耳罩
	請佩戴護目鏡。
	移動方向
	反應方向
	下一個處理步驟
	禁止的行為
	鏈鑽
	鑿擊
	Vario-Lock

符號	含義
	開動
	關閉
	鎖定起停開關
	解除起停開關的鎖定
	小轉速 / 衝擊次數
	大轉速 / 衝擊次數
	工具夾頭
	在工具插柄的末端塗抹少許油脂
	維修指示燈
P_1	額定輸入功率
E	單一衝擊強度符合 EPTA-Procedure 05/2009 的規定
n_0	無負載轉速
	防止再起動裝置
\emptyset	最大鑽孔直徑
	混凝土
	磚牆
	螺旋鑽頭
	衝破鑽頭
	空心鑽頭
	重量符合 EPTA-Procedure 01:2014
	絕緣等級
L_{wA}	聲功率水平
L_{pA}	聲壓水平
a_h	振動總值
K	不確定系數

供貨範圍

錘鑽，輔助手柄

安裝在機器上的工具以及圖表或說明上提到的附件，並不包含在基本供貨範圍中。

在本公司的附件清單中標列了完整的附件。

按照規定使用機器

本機器適合在混凝土，磚塊和石材上進行鉗鑽作業。另外也可以使用本機器進行鑿擊。

技術性數據

本產品的技術數據列在本使用說明書 37 頁的表格中。



本說明書提供的參數是以 230 伏特為依據，於低電壓地區，此數據有可能不同。

安裝和操作

以下表格顯示了在安裝和使用電動工具時的執行目的。表格中的圖形顯示了與執行目的相關的提示。因為用途不同所以會有不同的提示組合。請留心安全規章。

執行目的	圖片	請注意	頁數
安裝 SDS-max- 工具			38
拆除 SDS-max- 工具			38
選擇操作功能			39
改變鑿頭的位置 (Vario-Lock)			39
轉動輔助手柄			39
進行鑽孔作業時的開機 / 關機方式			40
進行鑿擊作業時的開機 / 關機方式			40

16 | 한국어

執行目的	圖片	請注意	頁數
調整轉速		8	40
留心維修指示燈		9	41

維修和清潔

▶ 電動工具和通風間隙都必須保持清潔，這樣才能夠提高工作品質和安全性。

如果必須更換連接線，務必把這項工作交給博世或者經授權的博世電動工具顧客服務處執行，以避免危害機器的安全性能。

維修指示燈

(參考插圖 9, 頁數 41)

如果碳刷耗盡了，電動工具會自動關閉。在碳刷即將用盡前 8 個小時，維修指示燈會亮起或閃爍。此時必須把電動工具交給博世顧客服務處維修。顧客服務處的地址請參閱“顧客服務處和顧客諮詢中心”。

如果維修指示燈有規律地閃爍，代表電動工具已經故障了。如果發生上述情況則不可以繼續使用電動工具，必須馬上將它交給顧客服務處修理。

顧客服務處和顧客諮詢中心

詢問和訂購備件時，務必提供機器銘牌上標示的 10 位數物品代碼。

本公司顧客服務處負責回答有關本公司產品的修理，維護和備件的問題。以下的網頁中有爆炸圖和備件的資料：

www.bosch-pt.com

博世顧客諮詢團隊非常樂意為您解答有關本公司產品及附件的問題。

台灣

台灣羅伯特博世股份有限公司

建國北路一段 90 號 6 樓

台北市 10491

電話：(02) 2515 5388

傳真：(02) 2516 1176

www.bosch-pt.com.tw

製造商地址：

Robert Bosch Power Tools GmbH

羅伯特·博世電動工具有限公司

70538 Stuttgart / GERMANY

70538 斯圖加特 / 德國

處理廢棄物

必須以符合環保的方式，回收再利用損壞的機器、附件和廢棄的包裝材料。

不可以把電動工具丟入家庭垃圾中。

保留修改權。

한국어

전동공구용 일반 안전수칙

⚠ 경고 모든 안전수칙과 지시 사항을 상세히 읽고 지켜야 합니다. 다음의 안전수칙과 지시 사항을 준수하지 않으면 화재 위험이 있으며 감전 혹은 중상을 입을 수 있습니다.

앞으로의 참고를 위해 이 안전수칙과 사용 설명서를 잘 보관하십시오.

다음에서 사용되는 “전동공구” 라는 개념은 전원에 연결하여 사용하는 전동 기기(전선이 있는)나 배터리를 사용하는 전동 기기(전선이 없는)를 의미합니다.

작업장 안전

- ▶ 작업장을 항상 깨끗이 하고 조명을 밝게 하십시오. 작업장 환경이 어수선하거나 어두우면 사고를 초래할 수 있습니다.
- ▶ 가연성 유체, 가스 또는 분진이 있어 폭발 위험이 있는 환경에서 전동공구를 사용하지 마십시오. 전동공구는 분진이나 증기에 점화하는 스파크를 일으킬 수 있습니다.
- ▶ 전동공구를 사용할 때 구경꾼이나 어린이 혹은 다른 사람이 작업장에 접근하지 못하게 하십시오. 다른 사람이 주의를 산만하게 하면 기기에 대한 통제를 잃기 쉽습니다.

전기에 관한 안전

- ▶ 전동공구의 전원 플러그가 전원 콘센트에 잘 맞아야 합니다. 플러그를 조금이라도 변경시켜서는 안됩니다. 접지된 전동공구를 사용할 때 어댑터 플러그를 사용하지 마십시오. 변형되지 않은 플러그와 잘 맞는 콘센트를 사용하면 감전의 위험을 감소할 수 있습니다.

- ▶ 파이프 관, 라디에이터, 레인지, 냉장고와 같은 접지 표면에 물이 닿지 않도록 하십시오. 물에 닿을 경우 감전될 위험이 높습니다.
- ▶ 전동공구를 비에 맞지 않게 하고 습기 있는 곳에 두지 마십시오. 전동공구에 물이 들어가면 감전될 위험이 높습니다.
- ▶ 전원 코드를 잡고 전동공구를 운반하거나 걸어 놓아서는 안되며, 콘센트에서 전원 플러그를 뽑을 때 전원 코드를 잡아 당겨서는 절대로 안됩니다. 전원 코드가 열과 오일에 접촉하는 것을 피하고, 날카로운 모서리나 기기의 가동 부위에 닿지 않도록 주의하십시오. 손상되거나 영긴 전원 코드는 감전을 유발할 수 있습니다.
- ▶ 실외에서 전동공구로 작업할 때는 실외용으로 적당한 연장 전원 코드만을 사용하십시오. 실외용 연장 전원 코드를 사용하면 감전의 위험을 줄일 수 있습니다.
- ▶ 전동공구를 습기 찬 곳에서 사용해야 할 경우에는 누전 차단기를 사용하십시오. 누전 차단기를 사용하면 감전 위험을 줄일 수 있습니다.

사용자 안전

- ▶ 신중하게 작업하십시오. 작업을 할 때 주의를 하며, 전동공구를 사용할 때 경솔하게 행동하지 마십시오. 피로한 상태이거나 약물 복용 및 음주한 후에는 전동공구를 사용하지 마십시오. 전동공구를 사용할 때 잠시라도 주의를 산만해지면 중상을 입을 수 있습니다.
- ▶ 작업자 안전을 위한 장치를 사용하십시오. 항상 보안경을 착용하십시오. 전동공구의 종류와 사용에 따라 먼지 보호 마스크, 미끄러지지 않는 안전한 신발, 안전모 또는 귀마개 등의 안전한 복장을 하면 상해의 위험을 줄일 수 있습니다.
- ▶ 실제로 기기가 작동되지 않도록 주의하십시오. 전동공구를 전원에 연결하거나 배터리를 끼우기 전에, 혹은 기기를 들거나 운반하기 전에, 전원 스위치가 꺼져 있는지 다시 확인하십시오. 전동공구를 운반할 때 전원 스위치가 손가락을 대거나 전원 스위치가 켜진 상태에서 전원을 연결하면 사고 위험이 높습니다.
- ▶ 전동공구를 사용하기 전에 조절하는 툴이나 나사 키 등을 빼 놓으십시오. 회전하는 부위에 있는 툴이나 나사 키로 인해 상처를 입을 수 있습니다.
- ▶ 자신을 과신하지 마십시오. 불안정한 자세를 피하고 항상 평형을 이룬 상태로 작업하십시오. 안정된 자세와 평형한 상태로 작업해야만이 의외의 상황에서도 전동공구를 안전하게 사용할 수 있습니다.
- ▶ 알맞은 작업복을 입으십시오. 헐렁한 복장을 하거나 장신구를 착용하지 마십시오. 머리카락 또는 장갑이 가동하는 기기 부위에 가까이 닿지 않도록 주의하십시오. 헐렁한 복장, 장신구 혹은 긴 머리는 가동 부위에 말려 사고를 초래할 수 있습니다.
- ▶ 분진 추출장치나 수거장치의 조립이 가능한 경우, 이 장치가 연결되어 있는지, 제대로 작동이 되는지 확인하십시오. 이러한 분진 추출장치를 사용하면 분진으로 인한 사고 위험을 줄일 수 있습니다.

전동공구의 올바른 사용과 취급

- ▶ 기기를 과부하 상태에서 사용하지 마십시오. 작업할 때 이에 적당한 전동공구를 사용하십시오. 알맞은 전동공구를 사용하면 지정된 성능 한도 내에서 더 효율적으로 안전하게 작업할 수 있습니다.
- ▶ 전원 스위치가 고장 난 전동공구를 사용하지 마십시오. 전원 스위치가 작동되지 않는 전동공구는 위험하므로, 반드시 수리를 해야 합니다.
- ▶ 기기에 세팅을 하거나 액세서리 부품을 교환하거나 혹은 기기를 보관할 때, 항상 전원 콘센트에서 플러그를 미리 빼어 놓으십시오. 이러한 조치는 실수로 전동공구가 작동하게 되는 것을 예방합니다.
- ▶ 사용하지 않는 전동공구는 어린이 손이 닿지 않는 곳에 보관하고, 전동공구 사용에 익숙지 않거나 이 사용 설명서를 읽지 않은 사람은 기기를 사용해서는 안됩니다. 경험이 없는 사람이 전동공구를 사용하면 위험합니다.
- ▶ 전동공구를 조심스럽게 관리하십시오. 가동 부위가 하자 없이 정상적인 기능을 하는지, 걸리는 부위가 있는지, 혹은 전동공구의 기능에 중요한 부품이 손상되지 않았는지 확인하십시오. 손상된 기기의 부품은 전동공구를 다시 사용하기 전에 반드시 수리를 맡기십시오. 제대로 관리하지 않은 전동공구의 경우 많은 사고를 유발합니다.
- ▶ 절단 공구를 날카롭고 깨끗하게 관리하십시오. 날카로운 절단면이 있고 잘 관리된 절단공구는 걸리는 경우가 드물고 조절하기도 쉽습니다.
- ▶ 전동공구, 액세서리, 장착하는 공구 등을 사용할 때, 이 지시 사항과 특별히 기종 별로 나와있는 사용 방법을 준수하십시오. 이때 작업 조건과 실시하려는 작업 내용을 고려하십시오. 원래 사용 분야가 아닌 다른 작업에 전동공구를 사용할 경우 위험한 상황을 초래할 수 있습니다.

서비스

- ▶ 전동공구 수리는 반드시 전문 인력에게 맡기고, 수리 정비 시 보쉬 순정 부품만을 사용하십시오. 그렇게 함으로써 기기의 안전성을 오래 유지할 수 있습니다.

해머용 안전 수칙

- ▶ 귀마개를 착용하십시오. 소음의 영향으로 인해 청각을 상실할 수 있습니다.
- ▶ 보조 손잡이가 전동공구와 함께 공급되는 경우 이를 사용하십시오. 통제를 잃게되면 상해를 입을 수 있습니다.
- ▶ 작업할 때 톱날이 보이지 않는 전선이나 기기 자체의 코드에 닿을 위험이 있으면 전동공구의 절연된 손잡이 면을 잡으십시오. 전류가 흐르는 전선에 접하게 되면 기기의 금속 부위에도 전기가 통해 감전될 위험이 있습니다.

18 | 한국어

기타 안전수칙 및 사용방법

- ▶ **배전 전압에 주의하십시오!** 공급되는 전원의 전압은 전 동공구의 명판에 표기된 전압과 동일해야 합니다.
- ▶ **보이지 않는 부위에 에너지 배선 및 배관여부를 확인 하려면 적당한 탐지기를 사용하거나 담당 에너지 공급 회사에 문의하십시오.** 전선에 접촉하게 되면 화재나 전기 충격을 유발할 수 있습니다. 가스관을 손상시키면 폭발 위험이 있으며 수도관을 파손하게 되면 재산 피해를 야기할 수 있습니다.
- ▶ **보호 손잡이를 세게 조이고, 작업 시 전동공구를 양 손 으로 꼭 잡고 안전한 자세를 취하십시오.** 전동공구를 양손으로 잡아야 안전하게 움직일 수 있습니다.
- ▶ **작업하려는 소재에 적절한 작동 모드와 적합한 비트를 사용하십시오.**
- ▶ **SDS-max 비트 장착하기:** 비트를 잡아당겨 보아 제대로 끼워졌는지 확인해 보십시오.
- ▶ **손상된 먼지 보호 캡은 즉시 교환하도록 하십시오.** 먼지 보호 캡은 작업하는 동안 먼지가 틀 홀더 안으로 들어가는 것을 방지해 줍니다. 비트를 장착할 때 먼지 보호 캡이 손상되지 않도록 주의하십시오.
- ▶ **납 성분을 함유한 페인트나 몇몇 목재 종류, 광물 및 금속 등 소재의 분진은 건강에 유해할 수 있으며 알레르기 반응이나 호흡기 질환 그리고 / 혹은 암을 유발할 수 있습니다.** 석면을 함유한 소재는 위험하므로 전문 인력들만이 작업해야 합니다.
 - 가능하면 작업물 소재에 적당한 분진 추출장치를 사용하십시오.
 - 작업장의 통풍이 잘 되도록 하십시오.
 - 필터등급 P2 가 장착된 호흡 마스크를 사용하십시오.

작업용 재료에 관해 국가가 지정한 규정을 고려 하십시오.
- ▶ **비트가 꼭 끼워져 움직이지 않는 경우 전동공구의 스위치를 끄십시오.** 비트를 풀어 주십시오.
- ▶ **전동공구의 스위치를 켜기 전에 비트가 자유로이 움직이는지 확인해 보십시오.** 비트가 걸려 있는 상태에서 스위치를 켜면 강한 반동력이 생길 수 있습니다.
- ▶ **에너지를 절약하기 위해 전동공구를 사용할 경우에만 스위치를 켜십시오.**
- ▶ **전동공구를 내려놓기 전에 기기가 완전히 멈추었는지를 확인하십시오.** 벨트가 걸려 전동공구에 대한 통제가 어려워질 수 있습니다.
- ▶ **재작동 보호장치**
재작동 보호장치는 치출 모드 시 전원이 나갔다가 다시 들어올 때 실수로 전동공구가 켜지는 것을 방지합니다.
 - **재시동을 하려면** 전원 스위치를 껐다가 전동공구의 스위치를 다시 켜면 됩니다.

▶ **진동 감소장치 (GBH 8-45 DV)**

















진동 감소장치가 있어 작업 중 발생하는 진동을 감소시켜 줍니다.

기호

다음에 나와있는 기호는 사용 설명서를 읽고 이해하는데 중요합니다. 그러므로 기호와 그 의미를 잘 기억하십시오. 기호를 제대로 이해하면 전동공구를 더욱 쉽고 안전하게 사용할 수 있습니다.

기호	의미
	GBH 8-45 D/ GBH 8-45 DV: 해머 드릴 회색 표시 부위: 손잡이 (절연 손잡이)
	제품 번호
	모든 안전 수칙과 지시 사항을 읽으십시오
	전동공구에 작업하기 전에 반드시 전원 콘센트에서 플러그를 빼십시오
	보호 장갑을 착용하십시오
	귀마개를 착용하십시오
	보안경을 착용하십시오
	이동 방향
	반동 방향
	다음 단계
	금지 사항
	해머 드릴작업

기호	의미
	치출작업
	Vario-Lock
	스위치 켜기
	스위치 끄기
	전원 스위치 고정하기
	전원 스위치 해제하기
	낮은 속도 / 타격을
	높은 속도 / 타격을
	툴 홀더
	비트의 끼우는 부위 끝에 약간 그리스를 바르십시오
	서비스 램프
P ₁	소비 전력
E	EPTA-Procedure 05/2009 에 따른 스트로크당 충격 에너지
n ₀	무부하 속도
	재작동 보호장치
∅	최대 드릴 직경
	콘크리트

기호	의미
	벽돌
	트위스트 드릴 비트
	관통 비트
	코어 드릴
	EPTA 공정 01:2014 에 따른 중량
	안전 등급
L _{WA}	음향 레벨
L _{PA}	음압 레벨
a _h	총 진동치
K	불확실성

공급 내역

해머 드릴, 보조 손잡이.
 도면이나 설명서에 나와 있는 비트와 액세서리는 기본 공급품에 속하지 않습니다.
 전체 액세서리는 본사 액세서리 프로그램을 참고하십시오.

규정에 따른 사용

본 제품은 콘크리트 벽돌 석재 등에 해머 드릴작업을 하거나 치출 작업을 하는 데 적합합니다.



제품 사양







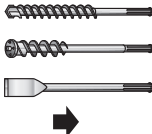

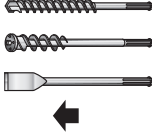

제품의 제품 사양은 본 사용 설명서의 37 면의 도표에 나와 있습니다.

자료는 정격 전압 [U] 230 V 를 기준으로 한 것입니다. 전압이 낮거나 각국의 특수한 모델에 따라 달라질 수 있습니다.

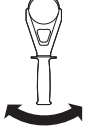
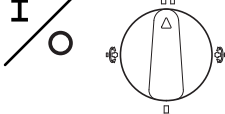
조립 및 작동

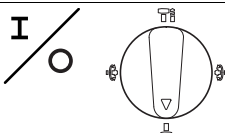
다음 도표에는 전동공구를 조립하고 작동하는데 필요한 작업 내용이 나와 있습니다. 작업 내용은 옆에 나온 그림으로 표시됩니다. 사용 분야에 따라 여러 내용을 조합하여 참고해야 합니다. 안전수칙을 준수하십시오.

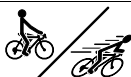
작업 내용	그림	준수 내용	페이지
페이지 SDS-max 비트 장착하기			38

20 한국어			
작업 내용	그림	준수 내용	페이지
SDS-max 비트 탈착하기			38
작동 모드 선택하기			39
치출 위치 변경하기 (Vario-Lock)			39
보조 손잡이 조절하기			39
드릴 모드 시 전원 스위치 작동			40
치출 모드 시 전원 스위치 작동			40
속도 조절			40
서비스 램프 확인하기			41

보수 정비 및 유지

▶ 안전하고 올바른 작동을 위하여 전동공구와 전동공구의 통풍구를 항상 깨끗이 하십시오.

연결 코드를 교환해야 할 경우 안전을 기하기 위해 보쉬 사나 보쉬 지정 전동공구 서비스 센터에 맡겨야 합니다.

서비스 램프

(그림 9, 41 페이지 참조)

카본 브러시가 수명이 다한 경우 전동공구의 작동이 자동으로 중단됩니다. 카본 브러시의 마모되기 약 8 시간 전에 서비스 램프가 켜지거나 깜박이며 이를 예고해 줍니다. 이 경우 전동공구를 고객 서비스 센터에 보내 보수 정비를 해야 합니다. 주소는 "AS 서비스 및 고객 상담" 난을 참고하십시오.

서비스 램프가 일정한 간격으로 깜박이면 전동공구가 고장입니다. 이 경우 전동공구를 계속 사용하지 말고 즉시 서비스 센터에 보내십시오.

보쉬 AS 및 고객 상담

문의 사항이 있거나 스페어 부품을 주문할 때 반드시 전동공구의 타입 표시판에 적힌 10 자리의 제품 번호를 알려 주십시오.

보쉬는 귀하의 제품 및 수리에 관한 문의를 받고 있습니다.

AS 센터 정보 및 제품에 대한 고객 상담은 하기 고객 콜센터 및 이메일 상담을 이용해주시기 바랍니다.

고객 콜센터 : 080-955-0909

이메일 상담 :

Bosch-pt.hotline@kr.bosch.com

한국로버트보쉬 (주)

경기도 용인시 기흥구 보정동 298 번지

www.bosch-pt.co.kr

처리

기기와 액세서리 및 포장 등은 친환경적인 방법으로 재활용할 수 있도록 분류하십시오.

전동공구를 가정용 쓰레기로 처리하지 마십시오!

위 사항은 사전 예고 없이 변경될 수도 있습니다.

ภาษาไทย**คำเตือนทั่วไปเพื่อความปลอดภัยในการใช้เครื่องมือไฟฟ้า**

คำเตือน ต้องอ่านคำเตือนเพื่อความปลอดภัยและคำสั่งทั้งหมด การไม่ปฏิบัติตามคำเตือนและคำสั่งอาจเป็นสาเหตุให้ถูกไฟฟ้าดูด เกิดไฟไหม้ และ/หรือได้รับบาดเจ็บอย่างร้ายแรง

เก็บรักษาคำเตือนและคำสั่งทั้งหมดสำหรับเปิดอ่านในภายหลัง

คำว่า "เครื่องมือไฟฟ้า" ในคำเตือนหมายถึง เครื่องมือไฟฟ้าของท่านที่ทำงานด้วยพลังงานไฟฟ้าที่ต่อจากเต้าเสียบ (มีสายไฟฟ้า) และเครื่องมือไฟฟ้าที่ทำงานด้วยพลังงานไฟฟ้าจากแบตเตอรี่ (ไร้สาย)

ความปลอดภัยในสถานที่ทำงาน

- ▶ รักษาสถานที่ทำงานให้สะอาดและมีไฟส่องสว่างดี สถานที่ที่มีมืดหรือรกยุ่งร้งนำมาซึ่งอุบัติเหตุ
- ▶ อย่าใช้เครื่องมือไฟฟ้าในสภาพแวดล้อมที่เสี่ยงต่อการติดระเบิดได้ เช่น ในที่มีขี้ของเหลว แก๊ส หรือฝุ่นที่ติดไฟได้ เมื่อใช้เครื่องมือไฟฟ้าจะเกิดประกายไฟซึ่งอาจจุดฝุ่นหรือไอให้ลุกเป็นไฟได้
- ▶ ขณะใช้เครื่องมือไฟฟ้าทำงาน ต้องกันเด็กและผู้ยืมดูให้ออกห่าง การหันเหความสนใจอาจทำให้ท่านขาดการควบคุมเครื่องได้

ความปลอดภัยเกี่ยวกับไฟฟ้า

- ▶ ปลั๊กของเครื่องมือไฟฟ้าต้องมีขนาดพอดีกับเต้าเสียบ อย่าดัดแปลงหรือแก้ไขตัวปลั๊กอย่างเด็ดขาด อย่าต่อปลั๊กต่อใดๆ เข้ากับเครื่องมือไฟฟ้าที่มีสายดิน ปลั๊กที่ไม่ดัดแปลงและเต้าเสียบที่เข้ากันช่วยลดความเสี่ยงจากการถูกไฟฟ้าดูด

- ▶ หลีกเลี่ยงไม่ให้ร่างกายสัมผัสกับพื้นผิวของสิ่งของที่ต่อสายดินไว้ เช่น ท่อ เครื่องทำความร้อน เตา และตู้เย็น จะเสี่ยงอันตรายจากการถูกไฟฟ้าดูดมากขึ้นหากกระแสไฟฟ้าวิ่งผ่านร่างกายของท่านลงดิน
- ▶ อย่าวางเครื่องมือไฟฟ้าตากฝนหรือทิ้งไว้ในที่ชื้นและหากนำเข้าไปในเครื่องมือไฟฟ้า จะเพิ่มความเสี่ยงจากการถูกไฟฟ้าดูด
- ▶ อย่าใช้สายไฟอย่างผิดๆ อย่าถือเครื่องมือไฟฟ้าที่สาย อย่าใช้สายแขวนเครื่อง หรืออย่าดึงสายไฟฟ้าเพื่อถอดปลั๊กออกจากเต้าเสียบ กันสายไฟฟ้าออกห่างจากความร้อน น้ำมัน ขอบแหลมคม หรือส่วนของเครื่องที่กำลังเคลื่อนไหว สายไฟฟ้าที่ชำรุดหรือพันกันยุ่ง เพิ่มความเสี่ยงจากการถูกไฟฟ้าดูด
- ▶ เมื่อใช้เครื่องมือไฟฟ้าทำงานกลางแจ้ง ให้ใช้สายไฟต่อที่ได้รับการรับรองให้ใช้ต่อในที่กลางแจ้งเท่านั้น การใช้สายไฟต่อที่เหมาะสมสำหรับงานกลางแจ้งช่วยลดอันตรายจากการถูกไฟฟ้าดูด
- ▶ หากไม่สามารถหลีกเลี่ยงการใช้เครื่องมือไฟฟ้าทำงานในสถานที่เปียกชื้นได้ ให้ใช้สวิทช์ตัดวงจรเมื่อเกิดการรั่วไหลของไฟฟ้าจากสายดิน การใช้สวิทช์ตัดวงจรเมื่อเกิดการรั่วไหลของไฟฟ้าจากสายดินช่วยลดความเสี่ยงต่อการถูกไฟฟ้าดูด

ความปลอดภัยของบุคคล

- ▶ ท่านต้องอยู่ในสภาพเตรียมพร้อม ระมัดระวังในสิ่งที่กำลังทำอยู่ และมีสติขณะใช้เครื่องมือไฟฟ้าทำงาน อย่าใช้เครื่องมือไฟฟ้าขณะที่ท่านกำลังเหนื่อย หรืออยู่ภายใต้การครอบงำของฤทธิ์ของยาเสพติด แอลกอฮอล์ และยา เมื่อใช้เครื่องมือไฟฟ้าทำงาน ในชั่วขณะที่ท่านขาดความเอาใจใส่อาจทำให้บุคคลบาดเจ็บอย่างรุนแรงได้
- ▶ ใช้อุปกรณ์ป้องกันร่างกาย สวมแว่นตาป้องกันเสมอ อุปกรณ์ปกป้อง เช่น หน้ากากกันฝุ่น รองเท้านิรภัย หมวกแข็ง หรือประภคพู่กันเสียงดัง ที่เลือกใช้ตามความเหมาะสมกับสภาพการทำงาน สามารถลดอันตรายต่อบุคคลได้
- ▶ ป้องกันการติดเครื่องโดยไม่ตั้งใจ ต้องดูให้แน่ใจว่าสวิทช์อยู่ในตำแหน่งปิดก่อนเสียบปลั๊กไฟเข้าไปในเต้าเสียบ และ/หรือใส่แท่งแบตเตอรี่ ชกขึ้นหรือถือเครื่องมือ การถือเครื่องโดยใช้นิ้วหัวที่สวิทช์ หรือเสียบปลั๊กไฟฟ้าขณะสวิทช์เปิดอยู่ อาจนำไปสู่อุบัติเหตุที่ร้ายแรงได้
- ▶ เอาเครื่องมือปรับแต่งหรือประแจปากตายออกจากเครื่องมือไฟฟ้าก่อนเปิดสวิทช์ เครื่องมือหรือประแจปากตายที่วางอยู่กับส่วนของเครื่องที่กำลังหมุนจะทำให้บุคคลบาดเจ็บได้

22 | ภาษาไทย

- ▶ **หลีกเลี่ยงการตั้งค่าที่ผิดพลาด** ตั้งทำยี่ห้อที่มั่นคงและวางน้ำหนักให้สมดุลตลอดเวลา ในลักษณะนี้ท่านสามารถควบคุมเครื่องมือไฟฟ้าในสถานการณ์ที่ไม่คาดคิดได้ดีกว่า
- ▶ **ใส่เสื้อผ้าที่เหมาะสม** อย่าใส่เสื้อผ้าหลวมหรือสวมเครื่องประดับ เอาหมวก เสื้อผ้า และถุงมือออกจากส่วนของเครื่องที่กำลังหมุน เสื้อผ้าหลวม เครื่องประดับ และผมยาวอาจเข้าไปติดในส่วนของเครื่องที่กำลังหมุนได้
- ▶ **หากต้องต่อเครื่องมือไฟฟ้าเข้ากับเครื่องดูดฝุ่นหรือเครื่องเก็บผง** ดูให้แน่ใจว่าการเชื่อมต่อและการใช้งานเป็นไปอย่างถูกต้อง การใช้อุปกรณ์ดูดฝุ่นช่วยลดอันตรายที่เกิดจากฝุ่นได้

การใช้และการดูแลรักษาเครื่องมือไฟฟ้า

- ▶ **อย่าใช้เครื่องมือไฟฟ้าอย่างหักโหม** ใช้เครื่องมือไฟฟ้าที่ถูกต้องตรงตามลักษณะงาน เครื่องมือไฟฟ้าที่ถูกต้องจะทำงานได้ดีกว่าและปลอดภัยกว่าในระดับสมรรถภาพที่ออกแบบไว้
- ▶ **อย่าใช้เครื่องมือไฟฟ้าที่สวิตช์เปิดปิดเสีย** เครื่องมือไฟฟ้าที่ไม่สามารถควบคุมการเปิดปิดด้วยสวิตช์ได้ เป็นเครื่องมือไฟฟ้าที่ไม่ปลอดภัยและต้องส่งซ่อมแซม
- ▶ **ก่อนปรับแต่งเครื่อง** เปลี่ยนอุปกรณ์ประกอบ หรือเก็บเครื่องเข้าที่ ต้องถอดปลั๊กไฟออกจากเต้าเสียบและ/หรือถอดแหงเบตเตอร์ออกจากเครื่องมือไฟฟ้า มาตรการป้องกันเพื่อความปลอดภัยนี้ช่วยลดความเสี่ยงจากการติดเครื่องโดยไม่ได้ตั้งใจ
- ▶ **เมื่อเลิกใช้งานเครื่องมือไฟฟ้า** ให้เก็บเครื่องไว้ในที่ที่เด็กหยิบไม่ถึง และไมอนุญาตให้บุคคลที่ไม่คุ้นเคยกับเครื่องหรือบุคคลที่ไม่ได้อ่านคำแนะนำนี้ใช้เครื่องมือไฟฟ้าเป็นของอันตรายหากตกอยู่ในมือของผู้ใช้ที่ไม่ได้รับการฝึกฝน
- ▶ **เอาใจใส่ดูแลรักษาเครื่อง** ตรวจสอบหาส่วนที่เคลื่อนไหวได้ของเครื่องว่าวางอยู่ตรงแนวหรือติดขัดหรือไม่ ตรวจสอบการแตกหักของชิ้นส่วนและสภาพอื่นใดที่อาจมีผลต่อการทำงานของเครื่องมือไฟฟ้า หากชำรุดต้องส่งเครื่องมือไฟฟ้าซ่อมแซมก่อนใช้งาน อุบัติเหตุหลายอย่างเกิดขึ้นเนื่องจากดูแลรักษาเครื่องไม่ดีพอ
- ▶ **รักษาเครื่องมือตัดให้คมและสะอาด** หากบำรุงรักษาเครื่องมือที่มีขอบตัดแหลมคมอย่างถูกต้อง จะสามารถตัดได้ลื่นไม่ติดขัดและควบคุมได้ง่ายกว่า
- ▶ **ใช้เครื่องมือไฟฟ้า อุปกรณ์ประกอบ เครื่องมือ และอุปกรณ์อื่นๆ ให้ตรงตามคำแนะนำนี้** และในลักษณะตามที่เครื่องมือไฟฟ้าประเภทนั้นๆ กำหนดไว้ โดยต้องคำนึงถึงเงื่อนไขการทำงานและงานที่จะทำด้วย การใช้เครื่องมือไฟฟ้าทำงานที่ต่างไปจากวัตถุประสงค์การใช้งานของเครื่อง อาจนำไปสู่สถานการณ์ที่เป็นอันตรายได้

การบริการ

- ▶ **ส่งเครื่องมือไฟฟ้าให้ช่างผู้เชี่ยวชาญตรวจสอบและใช้อะไหล่เปลี่ยนของแท้เท่านั้น** ในลักษณะนี้ท่านจะแน่ใจได้ว่าเครื่องมือไฟฟ้าอยู่ในสภาพที่ปลอดภัย

คำเตือนเพื่อความปลอดภัยสำหรับส่วนตอก

- ▶ **สวมประภคพ้องกันเสียงดัง** การรับฟังเสียงดังอาจทำให้ท่านสูญเสียการได้ยิน
- ▶ **หากด้ามจับเพิ่มจัดส่งมาพร้อมกับเครื่อง ให้ใช้ด้ามจับเพิ่มร่วมด้วย** การสูญเสียการควบคุมอาจทำให้บุคคลบาดเจ็บได้
- ▶ **เมื่อทำงานในบริเวณที่อุปกรณ์ตัดอาจสัมผัสกับสายไฟฟ้าที่ซ่อนอยู่หรือสายไฟฟ้าของเครื่อง** ต้องจับเครื่องมือไฟฟ้าตรงด้ามจับทั้งหมดจน หากอุปกรณ์ตัดสัมผัสกับสายที่มีกระแสไฟฟ้าไหลผ่านจะทำให้ส่วนที่เป็นโลหะของเครื่องมือไฟฟ้าเกิดมีกระแสไฟฟ้าด้วย และส่งผลให้ผู้ใช้เครื่องมือถูกไฟฟ้ากระชุกได้

วิธีปฏิบัติงานและคำแนะนำเพื่อความปลอดภัยเพิ่มเติม

- ▶ **ให้สังเกตแรงดันไฟฟ้า!** แรงดันไฟฟ้าจากแหล่งจ่ายไฟฟ้าต้องสอดคล้องกับข้อมูลบนแผ่นป้ายที่ติดของเครื่อง
- ▶ **ใช้เครื่องตรวจที่เหมาะสมตรวจหาท่อและสายไฟฟ้าที่อาจซ่อนอยู่ในบริเวณที่จะทำงาน** หรือขอความช่วยเหลือจากบริษัททางท่อและสายไฟฟ้าในท้องถิ่น การสัมผัสกับสาย ไฟฟ้าอาจทำให้เกิดไฟไหม้หรือถูกไฟฟ้าช็อกหรือดูดได้ การทำให้ท่อแก๊ซเสียหายอาจเกิดระเบิดได้ การเจาะเข้าในท่อน้ำ ทำให้ทรัพย์สินเสียหาย
- ▶ **ยึดด้ามจับเพิ่มให้แน่นหนา** จับเครื่องให้รัดกุมด้วยมือทั้งสองข้างขณะทำงาน และตั้งทำยี่ห้อที่มั่นคงและวางน้ำหนักให้สมดุลตลอดเวลา เครื่องจะถูกนำอย่างปลอดภัยด้วยมือทั้งสองข้าง
- ▶ **เลือกวิธีการปฏิบัติงานที่ถูกต้องและเครื่องมือที่เหมาะสมสำหรับวัสดุที่จะทำงาน**
- ▶ **ใส่เครื่องมือ SDS-max:** ดึงเครื่องมือเพื่อตรวจสอบการล็อก
- ▶ **เปลี่ยนฝาครอบกันฝุ่นที่ชำรุดในทันที** โดยส่วนใหญ่ฝาครอบกันฝุ่นช่วยป้องกันฝุ่นที่เกิดจากการเจาะไม่ให้เข้าไปในด้ามจับเครื่องมือขณะทำงาน เมื่อใส่เครื่องมือต้องระมัดระวังอย่าให้ฝาครอบกันฝุ่นชำรุด

▶ ผู้ที่ได้จากวัสดุ เช่น เคลือบผิวที่มีตะกั่ว ไม้ยางประเภทเรซาดู และโลหะ อาจเป็นอันตรายต่อสุขภาพและทำให้เกิดอาการแพ้ นำไปสู่โรคติดเชื้อในระบบหายใจและ/หรือโรคมะเร็ง ผู้ทำงานกับวัสดุผสมแอสเบสทอสได้ต้องเป็นช่างผู้เชี่ยวชาญเท่านั้น

- ใช้ระบบดูดฝุ่นออกที่เหมาะสมกับประเภทวัสดุ มากเท่าที่จะทำได้
- จัดสถานที่ทำงานให้มีการระบายอากาศที่ดี
- ขอแนะนำให้สวมหน้ากากป้องกันการติดเชื้อที่มีระดับ-ไส้กรอง P2

ปฏิบัติตามกฎข้อบังคับสำคัญอื่นๆ ที่เกี่ยวกับวัสดุชิ้นงานที่บังคับใช้ในประเทศของท่าน

▶ หากเครื่องมือเกิดติดขัด ให้ปิดสวิตช์เครื่อง คลายเครื่องมือออก

▶ ก่อนเปิดสวิตช์เครื่องมือไฟฟ้า ต้องตรวจสอบให้แน่ใจว่าเครื่องมือขยับเคลื่อนได้อย่างอิสระ หากเปิดสวิตช์โดยที่เครื่องมือเจาะติดขัดอยู่ อาจเกิดแรงปฏิกิริยาบิดสูง

▶ เพื่อประหยัดพลังงาน เปิดสวิตช์เครื่องมือไฟฟ้าเฉพาะเมื่อใช้งานเท่านั้น

▶ ก่อนวางเครื่องลงบนพื้นทุกครั้งต้องรอให้เครื่องหยุดนิ่งอยู่กับที่เสมอ มิฉะนั้นเครื่องมือที่ใส่อยู่อาจติดขัดและนำไปสู่การสูญเสียการควบคุมเครื่องมือไฟฟ้า

▶ การป้องกันการสตาร์ทอีกครั้ง

ในวิธีการปฏิบัติงานแบบสกด ระบบป้องกันการสตาร์ทอีกครั้งจะยับยั้งไม่ให้เครื่องสตาร์ทอย่างควบคุมไม่ได้หลังการจ่ายไฟฟ้าหยุดชะงัก

- สตาร์ทเครื่องทำงานอีกครั้ง สับสวิตช์เปิด-ปิด ไปยังตำแหน่งปิด และเปิดเครื่องทำงานอีกครั้ง

▶ ตัวหน่วงการสั่นสะเทือน (GBH 8-45 DV)

Vibration Control

ตัวหน่วงการสั่นสะเทือนที่รวมเบ็ดเสร็จอยู่ในเครื่องจะลดการสั่นสะเทือนที่เกิดขึ้น

สัญลักษณ์

สัญลักษณ์ต่อไปนี้มีความสำคัญต่อการอ่านและการทำความเข้าใจคู่มือการใช้งานเครื่อง กรุณาจดจำสัญลักษณ์และความหมายของสัญลักษณ์ การแปลความสัญลักษณ์ได้ถูกต้องจะช่วยให้ท่านใช้เครื่องได้ดีและปลอดภัยกว่า

สัญลักษณ์

ความหมาย

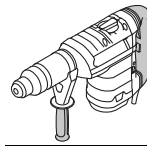

GBH 8-45 D/
GBH 8-45 DV: ส่วนโรตารี
บริเวณสีเทา: ตามจับ
(พื้นผิวจับหุ้มด้วยฉนวน)

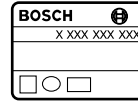

หมายเลขสินค้า



ต้องอ่านค่าเตือนเพื่อความปลอดภัยและคำสั่งทั้งหมด



ดึงปลั๊กไฟออกจากเต้าเสียบก่อนปรับแต่งเครื่อง



ต้องสวมถุงมือป้องกัน



ต้องสวมอุปกรณ์ป้องกันหู



ต้องสวมแว่นตานิรภัย/แว่นครอบตา



ทิศทางการเคลื่อนที่



ทิศทางการตอบสนอง



ขั้นตอนการกระทำต่อไป



การกระทำที่ห้าม



การเจาะตอก



การสกด



Vario-Lock



เปิดเครื่องทำงาน



ปิดเครื่อง



สวิตช์เปิด-ปิด ล็อคไว้



การปลดสวิตช์เปิด-ปิด

24 ภาษาไทย	
สัญลักษณ์	ความหมาย
	ความเร็ว/อัตรากระแทก ต่ำ
	ความเร็ว/อัตรากระแทก สูง
	ด้ามจับเครื่องมือ
	ทาสีบางๆ ตรงปลายเสียบของเครื่องมือ
	ไฟเตือนเข้ารับบริการ
P ₁	กำลังไฟฟ้าเข้ากำหนด
E	พลังงานกระแทกต่อครั้งตามระเบียบการ-EPTA-Procedure 05/2009
n ₀	ความเร็วรอบเดินตัวเปล่า
	การป้องกันการสแตร์ทอีกครั้ง
Ø	เส้นผ่าศูนย์กลางรูเจาะ สูงสุด
	คอนกรีต
	งานก่ออิฐ
	ดอกสว่านร่องเกลียว
	ดอกสว่านเจาะทะลวง
	ดอกเจาะแบบคว้านรู

สัญลักษณ์	ความหมาย
	น้ำหนักตามระเบียบการ-EPTA-Procedure 01:2014
	ระดับความปลอดภัย
L _{WA}	ระดับความดังเสียง
L _{pA}	ระดับความดันเสียง
a _h	ค่าความสั่นสะเทือนรวม
K	ความคลาดเคลื่อน

รายการสิ่งของที่จัดส่ง

สว่านโรตารี ด้ามจับเพิ่ม เครื่องมือ และอุปกรณ์ประกอบอื่นๆ ที่แสดงหรือระบุ ไม่รวมอยู่ในการจัดส่งมาตรฐาน กรุณาดูการอธิบายโดยสรุปทั้งหมดในโปรแกรมอุปกรณ์ประกอบของเรา

ประโยชน์การใช้งานของเครื่อง

เครื่องนี้ใช้สำหรับเจาะตอกในคอนกรีต อิฐ และหิน และสำหรับงานสกัด









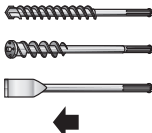

ข้อมูลทางเทคนิค

ข้อมูลทางเทคนิคของเครื่องได้ลงรายการไว้ในตารางหน้า 37 ของคู่มือการใช้งานเครื่องเล่มนี้ ค่าที่ใช้ได้กับแรงดันไฟฟ้าระบุ [U] 230 โวลท์ ค่าเหล่านี้ อาจผิดแผกไปสำหรับแรงดันไฟฟ้าที่ต่ำกว่า และโมเดลที่สร้างสำหรับเฉพาะประเทศ

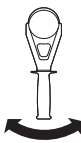
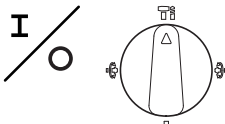
การประกอบและการปฏิบัติงาน

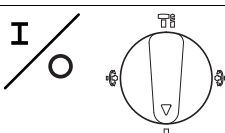
ตารางต่อไปนี้จะแสดงขั้นตอนการติดตั้งและการทำงานของเครื่องมือไฟฟ้า คำแนะนำสำหรับแต่ละขั้นตอนจะแสดงในภาพประกอบด้านข้าง อาจต้องใช้คำแนะนำที่หลากหลายรวมกันทั้งนี้ขึ้นอยู่กับประเภทการใช้งาน ปฏิบัติตามคำแนะนำเพื่อความปลอดภัย

ขั้นตอน	ภาพประกอบ	กรุณาปฏิบัติตาม	หน้า
ใส่เครื่องมือ SDS-max			38

ขั้นตอน	ภาพประกอบ	ภาพประกอบปฏิบัติตาม	หน้า	
การถอดเครื่องมือ SDS-max		2		38
การเลือกวิธีการปฏิบัติงาน		3		39
การเปลี่ยนตำแหน่งตอกสกัด (Vario-Lock)		4		39
การหมุนด้ามจับเพิ่ม		5		39
การเปิด-ปิดสวิตช์ในวิธีการปฏิบัติงานแบบเจาะ		6		40
การเปิด-ปิดสวิตช์ในวิธีการปฏิบัติงานแบบสกัด		7		40
การปรับความเร็วรอบ		8		40
การสังเกตไฟเตือนเข้ารับบริการ		9		41

การบำรุงรักษาและการทำความสะอาด

► เพื่อให้ทำงานได้อย่างถูกต้องและปลอดภัย ต้องรักษาเครื่องและช่องระบายอากาศให้สะอาดอยู่เสมอ

เมื่อจำเป็นต้องเปลี่ยนสายไฟฟ้า ให้ส่งเครื่องให้บริษัท บ็อชหรือศูนย์บริการลูกค้าสำหรับเครื่องมือไฟฟ้า บ็อช ที่ได้รับมอบหมายทำการเปลี่ยนให้ เพื่อหลีกเลี่ยงอันตรายด้านความปลอดภัย

ไฟเตือนเข้ารับบริการ

(ดูภาพประกอบ 9 หน้า 41)

เมื่อแปร่งถ่านหมดเครื่องจะปิดการทำงานเอง ก่อนแปร่งถ่านหมดประมาณ 8 ชั่วโมงไฟเตือนเข้ารับบริการ จะติดหรือกะพริบขึ้น ต้องส่งเครื่องไปยังศูนย์บริการหลังการขาย รายละเอียดที่อยู่ดูจากบท

"การบริการหลังการขายและคำแนะนำการใช้งาน"

หากไฟเตือนเข้ารับบริการกะพริบเป็นช่วงๆ อย่างสม่ำเสมอ แสดงว่าเครื่องบกพร่อง ในกรณีนี้อย่าใช้เครื่องต่อไป แต่ให้ส่งเครื่องไปยังศูนย์บริการหลังการขายในทันที

การบริการหลังการขายและคำแนะนำการใช้งาน

เมื่อต้องการสอบถามและสั่งซื้ออะไหล่ กรุณาแจ้งหมายเลขสินค้าหลักบนแผ่นป้ายรุ่นของเครื่องทุกครั้ง

ศูนย์บริการหลังการขายของเรายินดีตอบคำถามเกี่ยวกับการบำรุงรักษาและการซ่อมแซมผลิตภัณฑ์ของท่าน รวมทั้งชิ้นส่วนอะไหล่ ภาพแยกชิ้นประกอบและข้อมูลเกี่ยวกับชิ้นส่วนอะไหล่ยังสามารถดูได้ใน:

www.bosch-pt.com

ทีมงานให้คำแนะนำการใช้งานของ บ็อกซ์ ยินดีตอบคำถามเกี่ยวกับผลิตภัณฑ์ของเราและอุปกรณ์ประกอบของผลิตภัณฑ์ ในกรณีประกัน ซ่อมแซม หรือซื้อชิ้นส่วนมาเปลี่ยน กรุณาติดต่อ ผู้ขายที่ได้รับแต่งตั้งเท่านั้น

ไทย

บริษัท โรเบิร์ต บ็อกซ์ จำกัด
ชั้น 11 ตึกลิเบอร์ตี สแควร์

287 ถนนสีลม บางรัก

กรุงเทพฯ 10500

โทรศัพท์ 02 6393111, 02 6393118

โทรสาร 02 2384783

บริษัท โรเบิร์ต บ็อกซ์ จำกัด ตู้ ปณ. 2054

กรุงเทพฯ 10501 ประเทศไทย

www.bosch.co.th

ศูนย์บริการซ่อมและฝึกอบรม บ็อกซ์

อาคาร ลาซาลทาวเวอร์ ชั้น G ห้องเลขที่ 2

บ้านเลขที่ 10/11 หมู่ 16

ถนนศรีนครินทร์

ตำบลบางแก้ว อำเภอบางพลี

จังหวัดสมุทรปราการ 10540

ประเทศไทย

โทรศัพท์ 02 7587555

โทรสาร 02 7587525

การกำจัดขยะ

เครื่องมือ อุปกรณ์ประกอบ และที่บัพต้องนำไปแยกประเภทวัสดุเพื่อนำกลับมาใช้ใหม่โดยไม่ทำลายสภาพแวดล้อม

อย่าทิ้งเครื่องมือไฟฟ้าลงในขยะบ้าน!

ขอสงวนสิทธิ์ในการเปลี่ยนแปลงโดยไม่ต้องแจ้งล่วงหน้า

Bahasa Indonesia

Petunjuk-Petunjuk Umum untuk Perkakas Listrik

⚠ PERHATIKANLAH Bacalah semua petunjuk-petunjuk untuk keselamatan kerja dan petunjuk-petunjuk untuk penggunaan.

Kesalahan dalam menjalankan petunjuk-petunjuk untuk keselamatan kerja dan petunjuk-petunjuk untuk penggunaan dapat mengakibatkan kontak listrik, kebakaran dan/atau luka-luka yang berat.

Simpanlah semua petunjuk-petunjuk untuk keselamatan kerja dan petunjuk-petunjuk lainnya untuk penggunaan di masa depan.

Kata „perkakas listrik“ yang disebutkan di dalam petunjuk-petunjuk untuk keselamatan kerja adalah sebutan untuk perkakas listrik pakai listrik jaringan (dengan kabel) dan untuk perkakas listrik tenaga baterai (tanpa kabel listrik).

Keselamatan kerja di tempat kerja

- ▶ **Jagalah supaya tempat kerja selalu bersih dan terang.** Tempat kerja yang tidak rapi atau tidak terang dapat mengakibatkan terjadinya kecelakaan.
- ▶ **Janganlah menggunakan perkakas listrik di tempat di mana dapat terjadi ledakan, di mana ada cairan, gas atau debu yang mudah terbakar.** Perkakas listrik dapat memancarkan bunga api yang lalu mengakibatkan debu atau uap terbakar.
- ▶ **Selama menggunakan perkakas listrik, jauhkan anak-anak dan orang-orang lain dari tempat kerja.** Jika konsentrasi terganggu, bisa jadi Anda tidak bisa mengendalikan perkakas listrik tersebut.

Keamanan listrik

- ▶ **Steker dari perkakas listrik harus cocok pada stopkontak. Janganlah sekali-kali merubah steker.** Janganlah menggunakan steker perantara bersama dengan perkakas listrik yang mempunyai hubungan arde. Steker yang tidak dirubah dan stopkontak yang cocok mengurangi bahaya terjadinya kontak listrik.
- ▶ **Jagalah supaya badan Anda tidak bersentuhan dengan permukaan yang mempunyai hubungan arde, misalnya pipa-pipa, radiator pemanas ruangan, kompor listrik dan lemari es.** Ada risiko besar terjadi kontak listrik, jika badan Anda mempunyai hubungan arde.
- ▶ **Jagalah supaya perkakas listrik tidak kena hujan atau menjadi basah.** Air yang masuk ke dalam perkakas listrik menambah risiko terjadinya kontak listrik.
- ▶ **Janganlah menyalah gunakan kabel listrik untuk mengangkat dan menggantungkan perkakas listrik atau untuk menarik steker dari stopkontak. Jagalah supaya kabel listrik tidak kena panas, minyak, pinggiran yang tajam atau bagian-bagian perkakas yang bergerak.** Kabel listrik yang rusak atau tersangkut menambah risiko terjadinya kontak listrik.

- ▶ **Jika Anda menggunakan perkakas listrik di luar gedung, gunakanlah hanya kabel sambungan yang juga cocok untuk pemakaian di luar gedung.** Penggunaan kabel sambungan yang cocok untuk pemakaian di luar gedung mengurangi risiko terjadinya kontak listrik.
- ▶ **Jika penggunaan perkakas listrik di tempat yang basah tidak bisa dihindarkan, gunakanlah sakelar pengaman terhadap arus penyimpangan.** Penggunaan sakelar pengaman terhadap arus penyimpangan mengurangi risiko terjadinya kontak listrik.

Keselamatan kerja

- ▶ **Berhati-hatilah selalu, perhatikanlah apa yang Anda kerjakan dan bekerjalah dengan seksama jika menggunakan perkakas listrik. Janganlah menggunakan perkakas listrik, jika Anda capai atau berada di bawah pengaruh narkoba, minuman keras atau obat.** Jika Anda sekejap mata saja tidak berhati-hati sewaktu menggunakan perkakas listrik, dapat terjadi luka-luka berat.
- ▶ **Pakailah pakaian dan sarana pelindung dan pakailah selalu kaca mata pelindung.** Dengan memakai pakaian dan sarana pelindung, misalnya kedok anti debu (masker), sepatu tertutup yang tidak licin, helm pelindung atau pemalut telinga sesuai dengan pekerjaan yang dilakukan dengan perkakas listrik, bahaya terjadinya luka-luka dapat dikurangi.
- ▶ **Jagalah supaya perkakas listrik tidak dihidupkan secara tidak disengaja. Perhatikan bahwa perkakas listrik dalam penyetelan mati, jika steker disambungkan pada pengadaan listrik dan/atau baterai, jika perkakas listrik diangkat atau dibawa.** Jika selama mengangkat perkakas listrik jari Anda berada pada tombol untuk menghidupkan dan mematikan atau perkakas listrik yang dalam penyetelan hidup disambungkan pada listrik, dapat terjadi kecelakaan.
- ▶ **Lepaskan semua perkakas-perkakas penyetelan atau kunci-kunci pas sebelum perkakas listrik dihidupkan.** Perkakas atau kunci yang berada di dalam bagian yang berputar dapat mengakibatkan terjadinya luka-luka.
- ▶ **Aturkan badan sedemikian sehingga Anda bisa bekerja dengan aman. Berdirilah secara mantap dan jagalah selalu keseimbangan.** Dengan demikian Anda bisa mengendalikan perkakas listrik dengan lebih baik, jika terjadi sesuatu dengan tiba-tiba.
- ▶ **Pakailah pakaian yang cocok. Janganlah memakai pakaian yang longgar atau perhiasan. Jagalah supaya rambut, pakaian dan sarung tangan tidak masuk dalam bagian-bagian perkakas yang bergerak.** Pakaian yang longgar, rambut panjang atau perhiasan dapat tersangkut dalam bagian perkakas yang bergerak.
- ▶ **Jika ada kemungkinan untuk memasang sarana penghisapan dan penampungan debu, perhatikan bahwa sarana-sarana ini telah dipasangkan dan digunakan dengan betul.** Penggunaan sarana penghisapan bisa mengurangi bahaya yang disebabkan debu.

Penggunaan dan penanganan perkakas listrik dengan seksama

- ▶ **Janganlah membebankan perkakas listrik terlalu berat. Gunakan selalu perkakas listrik yang cocok untuk pekerjaan yang dilakukan.** Dengan perkakas listrik yang cocok Anda bekerja lebih baik dan lebih aman dalam batas-batas kemampuan yang ditentukan.
- ▶ **Janganlah menggunakan perkakas listrik yang tombolnya rusak.** Perkakas listrik yang tidak bisa dihidupkan atau dimatikan, berbahaya dan harus direparasikan.
- ▶ **Tariklah steker dari stopkontak dan/atau keluarkan baterai, sebelum Anda melakukan penyetelan pada perkakas listrik, mengganti alat-alat kerja atau sebelum menyimpan perkakas listrik.** Tindakan keselamatan kerja ini mengurangi bahaya perkakas listrik hidup secara tidak disengaja.
- ▶ **Simpanlah perkakas listrik yang tidak digunakan di luar jangkauan anak-anak. Janganlah mengizinkan orang-orang yang tidak mengenal perkakas listrik ini atau yang belum membaca petunjuk-petunjuk ini, menggunakan perkakas listrik ini.** Perkakas listrik bisa menjadi berbahaya, jika digunakan oleh orang-orang yang tidak mengenalnya.
- ▶ **Rawatlah perkakas listrik dengan seksama. Periksalah, apakah bagian-bagian perkakas listrik yang bergerak berfungsi dengan baik dan tidak tersangkut, apakah ada bagian-bagian yang patah atau rusak sedemikian, sehingga dapat mempengaruhi jalannya perkakas listrik. Biarkan bagian-bagian perkakas yang rusak direparasikan, sebelum Anda mulai menggunakan perkakas listrik.** Banyak kecelakaan terjadi karena perkakas listrik tidak dirawat dengan seksama.
- ▶ **Perhatikan supaya alat-alat pemotong selalu tajam dan bersih.** Alat-alat pemotong dengan mata-mata pemotong yang tajam dan dirawat dengan seksama tidak mudah tersangkut dan lebih mudah dikendalikan.
- ▶ **Gunakanlah semua perkakas listrik, aksesoris, alat-alat kerja dsb. sesuai dengan petunjuk-petunjuk. Perhatikan syarat-syarat kerja dan macam pekerjaan yang dilakukan.** Penggunaan perkakas listrik untuk macam pekerjaan yang tidak cocok dengan kegunaannya bisa mengakibatkan keadaan yang berbahaya.

Servis

- ▶ **Biarkan perkakas listrik Anda direparasikan hanya oleh orang-orang ahli yang berpengalaman dan hanya dengan menggunakan suku cadang yang asli.** Dengan demikian terjamin keselamatan kerja dengan perkakas listrik ini secara berkesinambungan.

28 | Bahasa Indonesia

Petunjuk-petunjuk untuk keselamatan kerja dengan palu

- ▶ **Pakailah pemalat telinga.** Jika Anda mendengar suara bising untuk waktu yang lama, daya pendengaran bisa berkurang.
- ▶ **Gunakanlah gagang tambahan-gagang tambahan, jika ini dipasok bersama dengan perkakas listrik.** Perkakas listrik yang tidak bisa dikendalikan bisa mengakibatkan terjadinya luka-luka.
- ▶ **Peganglah perkakas listrik hanya pada pegangan yang terisolir jika Anda melakukan pekerjaan yang memungkinkan alat pemotong ini menjalin kontak dengan kabel listrik yang tidak terlihat atau kabelnya sendiri.** Alat kerja yang bersentuhan dengan kabel yang bertegangan dapat mengakibatkan bagian-bagian logam dari perkakas listrik juga ikut dialiri tegangan arus dan mengakibatkan terjadinya kontak listrik.

Petunjuk-petunjuk lainnya untuk keselamatan kerja dan untuk penggunaan

- ▶ **Perhatikanlah tegangan jaringan listrik! Tegangan jaringan listrik harus sesuai dengan tegangan listrik yang tercantum pada label tipe perkakas listrik.**
- ▶ **Gunakanlah alat detektor logam yang cocok untuk mencari kabel dan pipa pengadaan yang tidak terlihat, atau hubungi perusahaan pengadaan setempat.** Sentuhan dengan kabel-kabel listrik bisa mengakibatkan api dan kontak listrik. Pipa gas yang dirusak bisa mengakibatkan ledakan. Pipa air yang dirusak mengakibatkan barang-barang menjadi rusak.
- ▶ **Kencangkan gagang tambahan sampai mantap, pegangan perkakas listrik selama bekerja dengannya secara kencang dengan kedua belah tangan dan berdirilah secara tegap.** Jika perkakas listrik dipegang dengan kedua belah tangan, perkakas listrik dapat dikendalikan dengan baik.
- ▶ **Pilihlah jenis penggunaan dan alat kerja yang cocok bagi bahan yang akan dikerjakan.**
- ▶ **Memasang alat kerja SDS-max:** Periksa apakah alat kerja sudah terkunci dengan cara menariknya.
- ▶ **Gantikanlah segera kap pelindung debu yang rusak (menjadi tidak mulus).** Kap pelindung debu menghindarkan debu pemboran masuk ke dalam pemegang alat kerja selama perkakas listrik digunakan. Selama memasang alat kerja, perhatikanlah supaya kap pelindung debu tidak menjadi rusak.
- ▶ **Debu dari berbagai bahan misalnya cat yang mengandung timbel, beberapa jenis kayu, bahan mineral dan logam bisa berbahaya bagi kesehatan dan mengakibatkan reaksi alergi, penyakit saluran pernafasan dan/atau kanker.** Bahan-bahan yang mengandung asbes hanya boleh dikerjakan oleh orang-orang ahli yang berpengalaman.

- Gunakanlah hanya penghisap debu yang cocok untuk menghisap bahan yang dikerjakan.
- Perhatikanlah supaya ada pertukaran udara di tempat kerja.
- Kami anjurkan supaya Anda memakai kedok anti debu dengan saringan (filter) kelas P2.

Taatilah peraturan-peraturan untuk bahan-bahan yang dikerjakan yang berlaku di negara Anda.

- ▶ **Jika alat kerja memblok, matikanlah segera perkakas listrik. Kendorkan alat kerjanya.**
- ▶ **Sebelum menghidupkan kembali perkakas listrik, periksalah apakah alat kerjanya sudah tidak memblok.** Jika perkakas listrik dihidupkan, padahal mata bor masih memblok, terjadi momen reaksi yang besar.
- ▶ Untuk menghemat energi, hidupkan perkakas listrik hanya jika Anda menggunakannya.
- ▶ **Sebelum meletakkan perkakas listrik, tunggulah sampai perkakas berhenti memutar.** Alat kerja bisa tersangkut dan membuat perkakas listrik tidak bisa dikendalikan.
- ▶ **Penghindar hidup ulang**
Penghindar hidup ulang menghindarkan perkakas listrik dalam jenis penggunaan memahat hidup secara tidak terkendali setelah pengadaan listrik mati.
 - Untuk **menghidupkan kembali** perkakas listrik, tombol untuk menghidupkan dan mematikan disetelkan pada posisi mati dan perkakas listrik dihidupkan kembali.
- ▶ **Peredaman getaran (GBH 8-45 DV)**









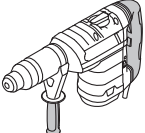
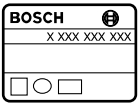

Peredaman getaran yang terpadu mengurangi getaran yang terjadi.

Simbol-Symbol

Simbol-simbol berikut penting pada waktu membaca dan untuk mengerti petunjuk-petunjuk untuk penggunaan. Lihat dan ingati simbol-simbol dan artinya. Penafsiran yang betul dari simbol-simbol sangat membantu Anda untuk menggunakan perkakas listrik dengan jitu dan sesuai dengan petunjuk untuk keselamatan kerja.

Simbol	Arti
	GBH 8-45 D/ GBH 8-45 DV: Mesin bor pakai hamering Bidang berwarna abu-abu: gagang (permukaan yang dipegang dengan isolasi)
	Nomor model
	Bacalah semua petunjuk-petunjuk untuk keselamatan kerja dan petunjuk-petunjuk untuk penggunaan

Simbol	Arti
	Sebelum melakukan semua pekerjaan pada perkakas listrik, tarikkan steker dari stopkontak
	Pakailah sarung tangan pelindung
	Pakailah pemalut telinga
	Pakailah kaca mata pelindung
	Arah gerakan
	Arah reaksi
	Kegiatan berikut
	Kegiatan yang dilarang
	Membor pakai hamering
	Memahat
	Vario-Lock
	Menghidupkan perkakas listrik
	Mematikan perkakas listrik
	Mengunci tombol untuk menghidupkan dan mematikan
	Membuka penguncian tombol untuk menghidupkan dan mematikan
	Kecepatan putaran/banyaknya getaran rendah
	Kecepatan putaran/banyaknya getaran tinggi
	Pemegang alat kerja
	Ujung pegang dari alat kerja harus dilumasi sedikit

Simbol	Arti
	Display tanda servis
P_1	Masukan nominal
E	Daya tiap-tiap getar sesuai dengan EPTA-Procedure 05/2009
n_0	Kecepatan putaran tanpa beban
	Penghindar hidup ulang
\emptyset	Diameter maks. pemboran
	Beton
	Tembok
	Mata bor berulir
	Mata bor untuk menembus
	Mata bor pipa
	Berat sesuai dengan EPTA-Procedure 01:2014
	Klasifikasi keamanan
L_{WA}	Nilai tenaga bunyi
L_{pA}	Tekanan bunyi
a_h	Nilai jumlah getaran
K	Ketidak tepatan

Pasokan standar

Mesin bor pakai hamering, gagang tambahan. Alat kerja dan aksesoris lainnya yang ada pada gambar atau yang dijelaskan tidak termasuk pasokan standar perkakas listrik.

Semua aksesoris yang tersedia dapat Anda lihat di dalam program aksesoris.

Penggunaan alat

Perkakas listrik ini cocok untuk membore dengan hamering pada beton, batu bata dan batu-batuan serta untuk pekerjaan memahat.

Data teknis

Data-data teknis dari produk ini tertera di dalam tabel pada halaman 37 dari petunjuk-petunjuk untuk penggunaan ini.

Data-data berlaku untuk tegangan nominal [U] 230 V. Pada tegangan yang lebih rendah dan pada model khusus mancanegara data-data ini bisa berlainan.

Memasang dan menggunakan

Tabel berikut ini menunjukkan tujuan dari kegiatan pemasangan dan pengoperasian perkakas listrik. Petunjuk-petunjuk untuk tujuan dari kegiatan dijelaskan dengan gambar-gambar. Tergantung dari jenis pengoperasian, dibutuhkan berbagai kombinasi yang berbeda dari petunjuk-petunjuk. Taatilah petunjuk-petunjuk untuk keselamatan kerja.

Kegiatan	Gambar	Perhatikanlah	Halaman
Memasang alat kerja SDS-max			38
Melepaskan alat kerja SDS-max			38
Memilih jenis penggunaan			39
Merubah penyetelan pahat (Vario-Lock)			39
Memutar gagang tambahan			39
Menghidupkan/mematikan perkakas listrik sewaktu membor			40
Menghidupkan/mematikan perkakas listrik sewaktu memahat			40
Menyetel kecepatan putaran			40
Perhatikan display tanda servis			41

Rawatan dan kebersihan

- ▶ **Perkakas listrik dan lubang ventilasi harus selalu dibersihkan supaya perkakas bisa digunakan dengan baik dan aman.**

Jika kabel listrik harus digantikan, pekerjaan ini harus dilakukan oleh Bosch atau Service Center untuk perkakas listrik Bosch yang resmi, supaya keselamatan kerja selalu terjamin.

Display tanda servis

(lihat gambar 9, halaman 41)

Jika karbon dinamo habis, perkakas listrik akan berhenti sendiri. Hal ini akan diperingatkan kira-kira 8 jam sebelumnya oleh display tanda servis yang menyala atau berkedip-kedip. Perkakas listrik harus dikirimkan ke Service Center untuk diservis, alamatnya lihat bab „Layanan pasca beli dan konseling terkait pengoperasian”.

Jika display tanda servis berkedip-kedip secara merata, perkakas listrik rusak. Dalam hal ini, janganlah meneruskan penggunaan perkakas listrik, melainkan kirimkannya segera ke Service Center Bosch.

Layanan pasca beli dan konseling terkait pengoperasian

Jika Anda hendak menanyakan sesuatu atau memesan suku cadang, sebutkan selalu nomor model yang terdiri dari 10 angka dan tercantum pada label tipe perkakas.

Layanan pasca beli Bosch menjawab semua pertanyaan Anda terkait reparasi dan maintenance serta suku cadang produk ini. Gambar tiga dimensi dan informasi terkait suku cadang dapat Anda lihat di:

www.bosch-pt.com

Tim konseling pengoperasian dari Bosch dengan senang hati membantu Anda, jika Anda hendak bertanya tentang produk-produk kami dan aksesorisnya.

Indonesia

PT. Multi Mayaka
Kawasan Industri Pulogadung
Jalan Rawa Gelam III No. 2
Jakarta 13930
Indonesia
Tel.: (021) 46832522
Fax: (021) 46828645/6823
E-Mail: sales@multimayaka.co.id
www.bosch-pt.co.id

Cara membuang

Perkakas listrik, aksesoris dan kemasan sebaiknya didaur ulang sesuai dengan upaya untuk melindungi lingkungan hidup.

Janganlah membuang perkakas listrik dalam sampah rumah tangga!

Perubahan dapat terjadi tanpa pemberitahuan sebelumnya.

Tiếng Việt

Cảnh báo tổng quát cách sử dụng an toàn dụng cụ điện cầm tay

⚠ CẢNH BÁO **Đọc kỹ mọi cảnh báo an toàn và hướng dẫn.** Không tuân thủ mọi

cảnh báo và hướng dẫn được liệt kê dưới đây có thể bị điện giật, gây cháy và/hay bị thương tật nghiêm trọng.

Hãy giữ tất cả tài liệu về cảnh báo và hướng dẫn để tham khảo về sau.

Thuật ngữ “dụng cụ điện cầm tay” trong phần cảnh báo là để cập đến sự sử dụng dụng cụ điện cầm tay của bạn, loại sử dụng điện nguồn (có dây cắm điện) hay vận hành bằng pin (không dây cắm điện).

Khu vực làm việc an toàn

- ▶ **Giữ nơi làm việc sạch và đủ ánh sáng.** Nơi làm việc bừa bộn và tối tăm dễ gây ra tai nạn.
- ▶ **Không vận hành dụng cụ điện cầm tay trong môi trường dễ gây nổ, chẳng hạn như nơi có chất lỏng dễ cháy, khí đốt hay rác.** Dụng cụ điện cầm tay tạo ra các tia lửa nên có thể làm rác bén cháy hay bốc khói.
- ▶ **Không để trẻ em hay người đến xem đứng gần khi vận hành dụng cụ điện cầm tay.** Sự phân tâm có thể gây ra sự mất điều khiển.

An toàn về điện

- ▶ **Phích cắm của dụng cụ điện cầm tay phải thích hợp với ổ cắm.** Không bao giờ được cải biến lại phích cắm dưới mọi hình thức. Không được sử dụng phích tiếp hợp nối tiếp đất (dây mát). Phích cắm nguyên bản và ổ cắm đúng loại sẽ làm giảm nguy cơ bị điện giật.
- ▶ **Tránh không để thân thể tiếp xúc với đất hay các vật có bề mặt tiếp đất như đường ống, lò sưởi, hàng rào và tủ lạnh.** Có nhiều nguy cơ bị điện giật hơn nếu cơ thể bạn bị tiếp hay nối đất.
- ▶ **Không được để dụng cụ điện cầm tay ngoài mưa hay ở tình trạng ẩm ướt.** Nước vào máy sẽ làm tăng nguy cơ bị điện giật.
- ▶ **Không được làm dụng dây dẫn điện.** Không bao giờ được nắm dây dẫn để xách, kéo hay rút phích cắm dụng cụ điện cầm tay. Không để dây gần nơi có nhiệt độ cao, dầu nhớt, vật nhọn bén hay bộ phận chuyển động. Làm hỏng hay cuộn rối dây dẫn làm tăng nguy cơ bị điện giật.

32 | Tiếng Việt

- ▶ **Khi sử dụng dụng cụ điện cầm tay ngoài trời, dùng dây nối thích hợp cho việc sử dụng ngoài trời.** Sử dụng dây nối thích hợp cho việc sử dụng ngoài trời làm giảm nguy cơ bị điện giật.
- ▶ **Nếu việc sử dụng dụng cụ điện cầm tay ở nơi ẩm ướt là không thể tránh được, dùng thiết bị ngắt mạch tự động (RCD) bảo vệ nguồn.** Sử dụng thiết bị ngắt mạch tự động RCD làm giảm nguy cơ bị điện giật.

An toàn cá nhân

- ▶ **Hãy tỉnh táo, biết rõ mình đang làm gì và hãy sử dụng ý thức khi vận hành dụng cụ điện cầm tay.** Không sử dụng dụng cụ điện cầm tay khi đang mệt mỏi hay đang bị tác động do chất gây nghiện, rượu hay dược phẩm gây ra. Một thoáng mất tập trung khi đang vận hành dụng cụ điện cầm tay có thể gây thương tích nghiêm trọng cho bản thân.
- ▶ **Sử dụng trang bị bảo hộ cá nhân.** Luôn luôn đeo kính bảo vệ mắt. Trang bị bảo hộ như khẩu trang, giày chống trượt, nón bảo hộ, hay dụng cụ bảo vệ tai khi được sử dụng đúng nơi đúng chỗ sẽ làm giảm nguy cơ thương tật cho bản thân.
- ▶ **Phòng tránh máy khởi động bất ngờ.** Bảo đảm công tắc máy ở vị trí tắt trước khi cắm vào nguồn điện và/hay lắp pin vào, khi nhắc máy lên hay khi mang xách máy. Ngáng ngón tay vào công tắc máy để xách hay kích hoạt dụng cụ điện cầm tay khi công tắc ở vị trí mở để dẫn đến tai nạn.
- ▶ **Lấy mọi chìa hay khóa điều chỉnh ra trước khi mở điện dụng cụ điện cầm tay.** Khóa hay chìa còn gắn dính vào bộ phận quay của dụng cụ điện cầm tay có thể gây thương tích cho bản thân.
- ▶ **Không rướn người.** Luôn luôn giữ tư thế đứng thích hợp và thẳng bằng. Điều này tạo cho việc điều khiển dụng cụ điện cầm tay tốt hơn trong mọi tình huống bất ngờ.
- ▶ **Trang phục thích hợp.** Không mặc quần áo rộng lủng thụng hay mang trang sức. Giữ tóc, quần áo và găng tay xa khỏi các bộ phận chuyển động. Quần áo rộng lủng thụng, đồ trang sức hay tóc dài có thể bị cuốn vào các bộ phận chuyển động.
- ▶ **Nếu có các thiết bị đi kèm để nối máy hút bụi và các phụ kiện khác, bảo đảm các thiết bị này được nối và sử dụng tốt.** Việc sử dụng các thiết bị gom hút bụi có thể làm giảm các độc hại liên quan đến bụi gây ra.

Sử dụng và bảo dưỡng dụng cụ điện cầm tay

- ▶ **Không được ép máy.** Sử dụng dụng cụ điện cầm tay đúng loại theo đúng ứng dụng của bạn. Dụng cụ điện cầm tay đúng chức năng sẽ làm việc tốt và an toàn hơn theo đúng tiến độ mà máy được thiết kế.
- ▶ **Không sử dụng dụng cụ điện cầm tay nếu như công tắc không tắt và mở được.** Bất kỳ dụng cụ điện cầm tay nào mà không thể điều khiển được bằng công tắc là nguy hiểm và phải được sửa chữa.
- ▶ **Rút phích cắm ra khỏi nguồn điện và/hay pin ra khỏi dụng cụ điện cầm tay trước khi tiến hành bất kỳ điều chỉnh nào, thay phụ kiện, hay cất dụng cụ điện cầm tay.** Các biện pháp ngăn ngừa như vậy làm giảm nguy cơ dụng cụ điện cầm tay khởi động bất ngờ.
- ▶ **Cất giữ dụng cụ điện cầm tay không dùng tới nơi trẻ em không lấy được và không cho người chưa từng biết dụng cụ điện cầm tay hay các hướng dẫn này sử dụng dụng cụ điện cầm tay.** Dụng cụ điện cầm tay nguy hiểm khi ở trong tay người chưa được chỉ cách sử dụng.
- ▶ **Bảo quản dụng cụ điện cầm tay.** Kiểm tra xem các bộ phận chuyển động có bị sai lệch hay kẹt, các bộ phận bị rạn nứt và các tình trạng khác có thể ảnh hưởng đến sự vận hành của máy. Nếu bị hư hỏng, phải sửa chữa máy trước khi sử dụng. Nhiều tai nạn xảy ra do bảo quản dụng cụ điện cầm tay tối.
- ▶ **Giữ các dụng cụ cắt bén và sạch.** Bảo quản đúng cách các dụng cụ cắt có cạnh cắt bén làm giảm khả năng bị kẹt và dễ điều khiển hơn.
- ▶ **Sử dụng dụng cụ điện cầm tay, phụ kiện, đầu cài v. v., đúng theo các chỉ dẫn này, hãy lưu ý đến điều kiện làm việc và công việc phải thực hiện.** Sử dụng dụng cụ điện cầm tay khác với mục đích thiết kế có thể tạo nên tình huống nguy hiểm.

Bảo dưỡng

- ▶ **Đưa dụng cụ điện cầm tay của bạn đến thợ chuyên môn để bảo dưỡng, chỉ sử dụng phụ tùng đúng chủng loại để thay.** Điều này sẽ đảm bảo sự an toàn của máy được giữ nguyên.

Các Cảnh Báo An Toàn Cho Khoan Búa

- ▶ **Hãy mang dụng cụ bảo vệ tai.** Để tai trần tiếp xúc với tiếng ồn có thể làm mất thính giác.

- ▶ **Hãy sử dụng tay nắm phụ, nếu như được giao kèm với dụng cụ.** Sự mất điều khiển có thể gây thương tích cho bản thân.
- ▶ **Nắm giữ dụng cụ điện nơi phần nắm cách điện khi thực hiện việc gia công nơi dụng cụ cắt có thể chạm vào dây điện không nhìn thấy được hay chính dây của máy.** Dụng cụ cắt chạm phải dây có điện có thể làm cho các bộ phận kim loại không được bao bọc có điện và giết người vận hành máy.

Các Hướng Dẫn An Toàn và Vận Hành Bổ Sung

- ▶ **Tuân thủ theo đúng điện thế!** Điện thế nguồn chính phải đúng với các dữ liệu được ghi trên nhãn máy.
- ▶ **Sử dụng thiết bị dò tìm thích hợp để xác định các đường hay ống dẫn công ích nằm âm trong khu vực làm việc hay liên hệ với cty công trình phức lợi để nhờ giúp đỡ.** Tiếp xúc với dây điện có thể dẫn đến cháy và bị điện giật. Chạm đường dẫn khí đốt có thể gây nổ. Làm thủng ống dẫn nước có thể làm hư hại tài sản hay có thể gây ra điện giật.
- ▶ **Vận thật chặt tay nắm phụ, giữ máy thật chặt bằng cả hai tay trong khi làm việc và luôn luôn giữ tư thế đứng thích hợp và cân bằng trong mọi lúc.** Máy được điều khiển an toàn bằng cả hai tay.
- ▶ **Chọn đúng chế độ hoạt động và dụng cụ ứng dụng thích hợp cho vật liệu được gia công.**
- ▶ **Lắp dụng cụ ứng dụng SDS-max:** Kiểm tra xem đã cài chắc chưa bằng cách kéo thử dụng cụ ra.
- ▶ **Thay chụp bảo vệ ngăn bụi bị hư hỏng ngay lập tức.** Chụp bảo vệ ngăn bụi ngăn cản phần lớn sự xâm nhập của bụi khoan vào trong bộ phận gá lắp dụng cụ trong thời gian hoạt động. Khi lắp dụng cụ vào, hãy lưu ý rằng chụp bảo vệ ngăn bụi không bị làm hư hỏng.
- ▶ **Bụi từ các vật liệu như là lớp phủ có chứa chì, một số loại gỗ, khoáng chất và kim loại có thể gây nguy hại đến sức khỏe và gây dị ứng, dẫn đến sự nhiễm trùng đường hô hấp và/hay gây ung thư.** Vật liệu chứa amiăng có thể chỉ nên để cho các thợ chuyên môn gia công.
 - Cách xa ở mức có thể được, sử dụng hệ thống hút thích hợp cho loại vật liệu.
 - Tạo không khí thông thoáng nơi làm việc.
 - Khuyến nghị nên mang mặt nạ phòng độc có bộ lọc cấp P2.

Tuân thủ các qui định của quốc gia bạn liên quan đến loại vật liệu gia công.

- ▶ **Nếu giả sử như dụng cụ ứng dụng bị kẹt cứng, hãy tắt máy. Làm rời dụng cụ ứng dụng ra.**
- ▶ **Trước khi cho dụng cụ điện hoạt động, bảo đảm rằng dụng cụ ứng dụng chuyển động được tự do.** Khi mở máy mà dụng cụ ứng dụng bị kẹt cứng, lực xoắn vận cao có thể xảy ra.
- ▶ Để tiết kiệm năng lượng, chỉ cho dụng cụ điện hoạt động khi sử dụng.
- ▶ **Luôn luôn đợi cho máy hoàn toàn ngừng hẳn trước khi đặt xuống.** Dụng cụ lắp vào máy có thể bị kẹp chặt dẫn đến việc dụng cụ điện cầm tay bị mất điều khiển.
- ▶ **Chống sự khởi động lại**
Trong chế độ đọc, bộ phận chống sự khởi động lại phòng chống máy khởi động ngoài tầm điều khiển sau khi bị mất điện.
 - Để **vận hành lại**, bật công tắc Tắt/Mở về vị trí Tắt và khởi động máy lại.

▶ Bộ Phận Giảm Chấn (GBH 8-45 DV)



Bộ phận giảm chấn nội kết làm giảm sự rung chấn phát sinh.

Các Biểu Tượng

Các biểu tượng sau đây mang ý nghĩa quan trọng để suy diễn và hiểu các hướng dẫn sử dụng. Xin vui lòng lưu ý đến các biểu tượng và ý nghĩa của chúng. Sự hiểu đúng các biểu tượng sẽ giúp bạn sử dụng máy một cách tốt và an toàn hơn.

Biểu Tượng	Ý Nghĩa
	GBH 8-45 D/ GBH 8-45 DV: Khoan Búa Phạm vi có màu xám: Tay nắm (phần nắm được cách điện)
	Mã số máy
	Đọc tất cả các cảnh báo an toàn và mọi hướng dẫn
	Trước khi thực hiện bất cứ việc gì trên máy, rút phích cắm ra khỏi ổ điện nguồn

34 | Tiếng Việt

Biểu Tượng	Ý Nghĩa
	Hãy mang găng tay bảo vệ
	Mang dụng cụ bảo vệ tai
	Mang kính an toàn/kính bảo hộ lao động
	Chiều chuyển động
	Chiều phản ứng
	Bước hành động kế tiếp
	Hành động bị cấm
	Khoan Búa
	Đục
	Vario-Lock (Khóa nhiều vị trí)
	Mở công tắc
	Để tắt máy
	Công tắc Tắt/Mở được khóa tự-chạy
	Nhả công tắc Tắt/Mở
	Tốc độ chậm/tần suất đập
	Tốc độ cao/tần suất đập
	Phần lắp dụng cụ
	Bôi một ít mỡ bôi trơn vào chuỗi lắp dụng cụ ứng dụng
	Đèn Cảnh Báo Hoạt Động
P_1	Công suất vào danh định

Biểu Tượng	Ý Nghĩa
E	Năng lượng va đập của từng hành trình dựa theo Qui Chuẩn-EPTA 05/2009
n_0	Tốc độ không tải
	Chống sự khởi động lại
\emptyset	Đường kính khoan, tối đa
	Bê-tông
	Công trình xây gạch
	Mũi khoan xoắn
	Mũi khoan xuyên phá
	Mũi khoan lõi
	Trọng lượng theo Qui trình EPTA-Procedure 01:2014 (chuẩn EPTA 01:2014)
	Cấp độ bảo vệ
L_{WA}	Cấp độ công suất âm thanh
L_{PA}	Cấp độ áp lực âm thanh
a_h	Tổng trị số độ rung
K	Bất định

Các món được giao

Khoan búa xoay, tay nắm phụ.
Dụng cụ ứng dụng và các phụ kiện khác được trình bày hay mô tả không phải là một phần của khuôn khổ tiêu chuẩn hàng được giao.

Bạn có thể tìm thấy thông tin mô tả tổng quát các phụ kiện trong chương trình phụ kiện của chúng tôi.

Dành sử dụng cho

Máy được thiết kế để khoan búa bê-tông, gạch và đá cũng như dùng để đục.

Thông số kỹ thuật

Tính năng kỹ thuật của máy được liệt kê trong Bảng ở trang 37 của các hướng dẫn sử dụng này.

Các giá trị đã cho có hiệu lực cho điện thế danh định [U] 230 V. Đối với điện thế thấp hơn và các loại máy dành riêng cho một số quốc gia, các giá trị này có thể thay đổi.

Lắp và Vận Hành

Biểu bảng sau đây chỉ rõ các thao tác cho mục đích lắp ráp và vận hành dụng cụ điện. Sự hướng dẫn cho từng thao tác mục đích được trình bày bên cạnh. Tùy theo loại hình ứng dụng, sự kết hợp một số hướng dẫn là cần thiết. Tuân thủ các hướng dẫn cho sự an toàn.

Loại công việc	Hình ảnh	Xin vui lòng tuân thủ	Trang
Lắp dụng cụ ứng dụng SDS-max			38
Tháo dụng cụ ứng dụng SDS-max			38
Chọn Chế Độ Hoạt Động			39
Thay đổi tư thế của mũi đục (Vario-Lock/Khóa nhiều vị trí)			39
Xoay Tay Nắm Phụ			39
Tắt/Mở máy ở Chế độ Khoan			40
Tắt/Mở máy ở Chế độ Đục			40
Điều chỉnh tốc độ			40
Tuân theo đèn cảnh báo hoạt động			41

36 | Tiếng Việt

Bảo Dưỡng Và Làm Sạch

► **Để được an toàn và máy hoạt động đúng chức năng, luôn luôn giữ máy và các khe thông gió được sạch.**

Nếu như cần phải thay dây dẫn điện thì công việc này phải do hãng Bosch, hay một đại lý được Bosch ủy nhiệm thực hiện để tránh gặp sự nguy hiểm do mất an toàn.

Đèn Cảnh Báo Hoạt Động

(xem hình 9, trang 41)

Khi chổi than đã mòn hết, máy tự tắt. Điều này được báo trước khoảng 8 giờ đồng hồ bằng sự sáng lên hay nhấp nháy của đèn cảnh báo hoạt động. Sau đó máy phải được mang đến đại lý phục vụ hậu mãi. Địa chỉ của các đại lý này được liệt kê trong Phần "Dịch Vụ Sau Khi Bán và Dịch Vụ Ứng Dụng".

Đèn cảnh báo hoạt động nháy sáng cách quãng, máy đã bị hư hỏng. Trong trường hợp này, không được tiếp tục sử dụng máy và hãy gửi ngay máy đến đại lý bảo hành bảo trì để sửa chữa.

Dịch Vụ Sau Khi Bán và Dịch Vụ Ứng Dụng

Trong mọi thư từ giao dịch và đơn đặt hàng phụ tùng, xin vui lòng luôn viết đủ 10 con số đã được ghi trên nhãn máy.

Bộ phận phục vụ hàng sau khi bán của chúng tôi sẽ trả lời các câu hỏi liên quan đến việc bảo trì và sửa chữa các sản phẩm cũng như các phụ tùng thay thế của bạn. Hình ảnh chi tiết và thông tin phụ tùng thay thế có thể tìm hiểu theo địa chỉ dưới đây:

www.bosch-pt.com

Bộ phận dịch vụ ứng dụng Bosch sẽ hân hạnh trả lời các câu hỏi liên quan đến các sản phẩm của chúng tôi và linh kiện của chúng.

Việt Nam







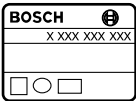

Công ty Trách Nhiệm Hữu Hạn Robert Bosch
Việt Nam, PT/SVN
Tầng 10, 194 Golden Building
473 Điện Biên Phủ
Phường 25, Quận Bình Thạnh
Thành Phố Hồ Chí Minh
Việt Nam
Tel.: (08) 6258 3690 Ext 413
Fax: (08) 6258 3692
hieu.lagia@vn.bosch.com
www.bosch-pt.com

Thải bỏ

Máy, linh kiện và bao bì phải được phân loại để tái chế theo hướng thân thiện với môi trường.

Không được thải bỏ dụng cụ điện vào chung với rác sinh hoạt!

Được quyền thay đổi nội dung mà không phải thông báo trước.

		GBH 8-45 D	GBH 8-45 DV
		3 611 B65 1..	3 611 B65 0..
P_1	W	1500	1500
E	J	12,5	12,5
n_0	min^{-1}	0 - 305	0 - 305
		●	●
		-	●
Ø max.			
			
	mm	45	45
			
	mm	80	80
			
	mm	125	125
			
	kg	8,2	8,9
		II	II

38 |

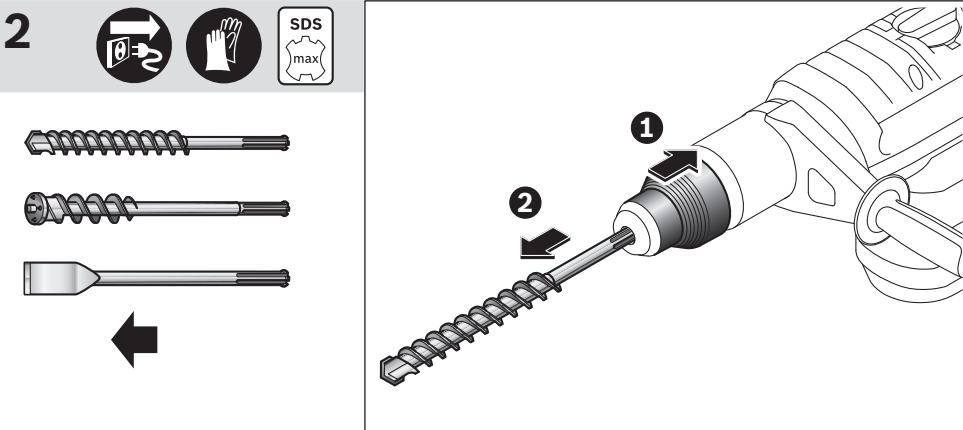
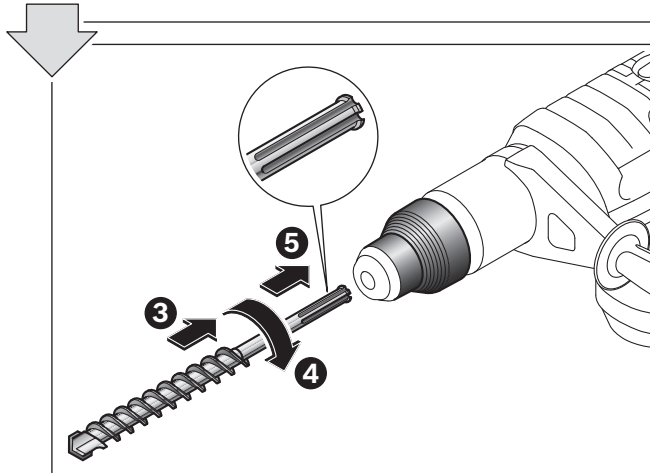
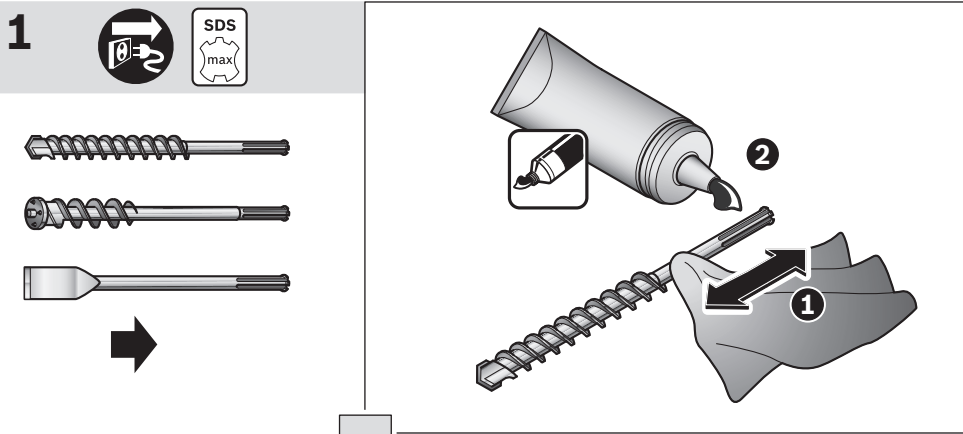

3

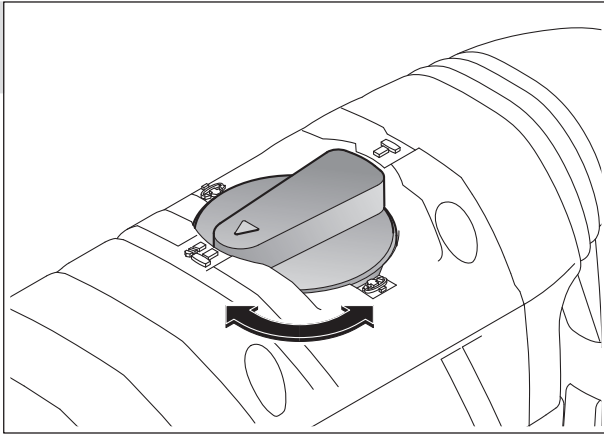

4

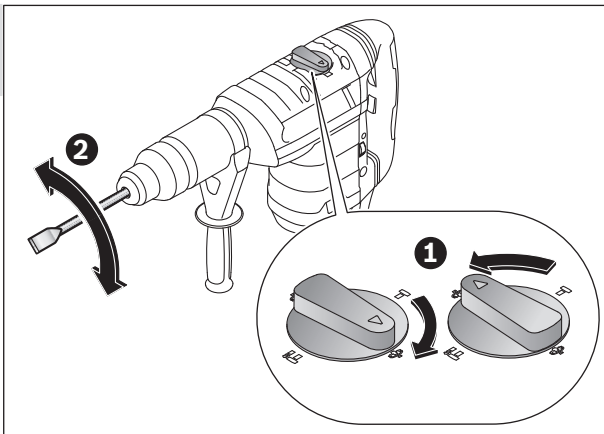

5

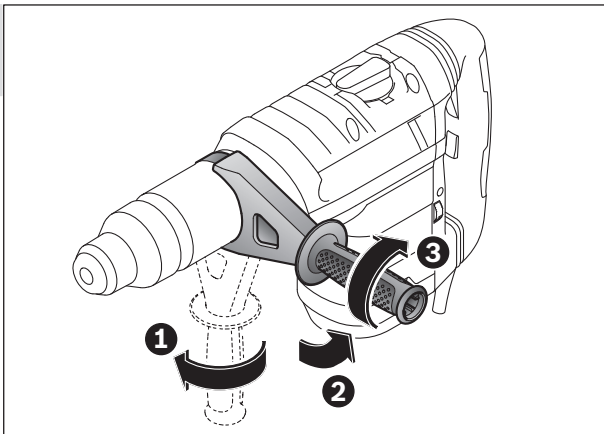
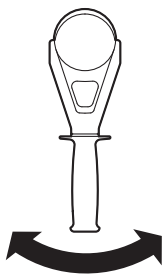

40 |

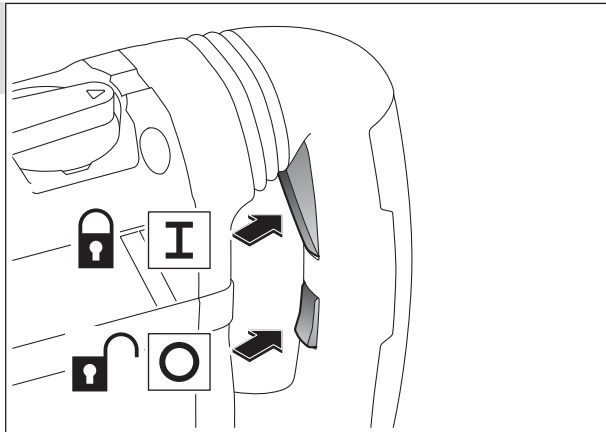
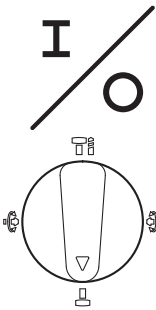
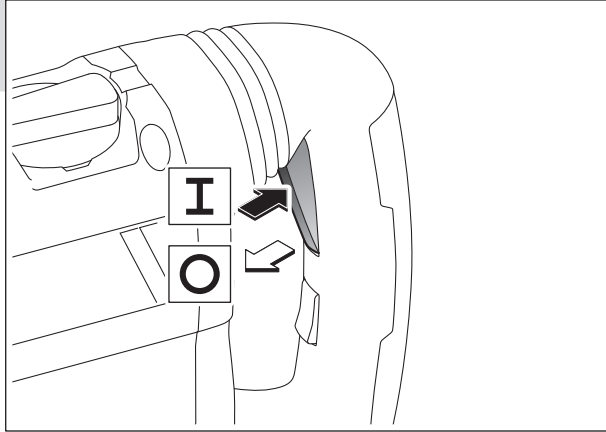
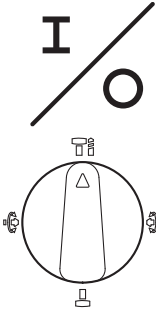

8

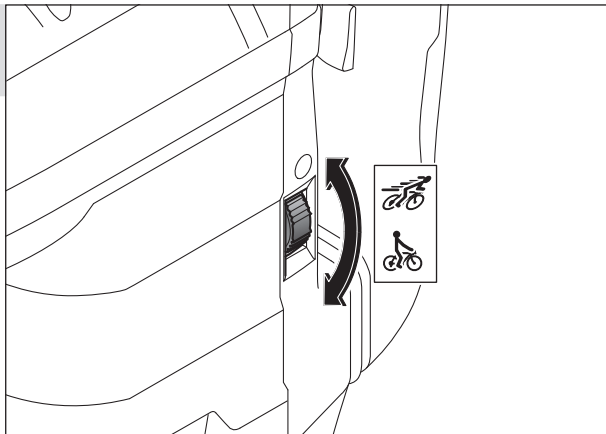

9

